

F B Gearing



Total Motion Control

Harmonic Drive™ gear

Precision Gearing and Motion Control

Contents

Compact, High Ratio, In-Line Gearing	2
The Basic Component Set	2
Configuration	3
Typical Installation	3
Ordering Information	3
Dimensions	4
Performance Ratings	5
Lubrication	6
Installation	6
Efficiency	7
No-Load Running Torque, Starting Torque, and Back Driving Torque	7

Compact, High Ratio, In-Line Gearing

Harmonic Drive™ FB “Pancake” type component set offers the designer high ratio, in-line mechanical power transmissions in extremely compact configurations. The component set consists of four elements: the Wave generator, an elliptical bearing assembly; the Flexspline, a non-rigid ring with external teeth; and the Circular Spline and the Dynamic Spline, rigid internal gears.

Rotation of the Wave Generator imparts a rotating elliptical shape to the Flexspline causing progressive engagement of its external teeth with the internal teeth of the Circular Spline and the Dynamic Spline. The fixed Circular Spline has two more teeth than the Flexspline, thereby imparting relative rotation to the Flexspline at a reduction ratio corresponding to the difference in the number of teeth. With the same number of teeth, the Dynamic Spline rotates with and at the same speed as the Flexspline.

The Basic Component Set

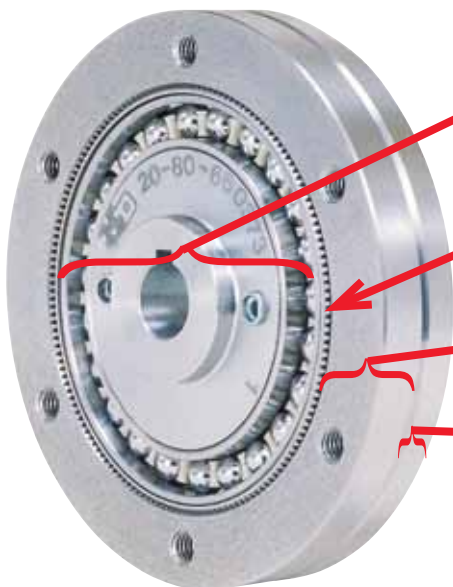

- 1) The Wave generator (WG) is a thin raced bearings assembly fitted onto an elliptical plug, and normally is the rotating input member.
- 2) The Flexspline (FS) is a non-rigid ring with external teeth on a slightly smaller pitch diameter than the Circular Spline. It is fitted over and is elastically deflected by the Wave Generator.
- 3) The Circular Spline (CS) is a rigid ring with internal teeth, engaging the teeth of the Flexspline across the major axis of the Wave Generator.
- 4) The Dynamic Spline (DS) is a rigid ring having internal teeth of same number as the Flexspline. It rotates together with the Flexspline and serves as the output member. It is identified by chamfered corners at its outside diameter.

Configurations

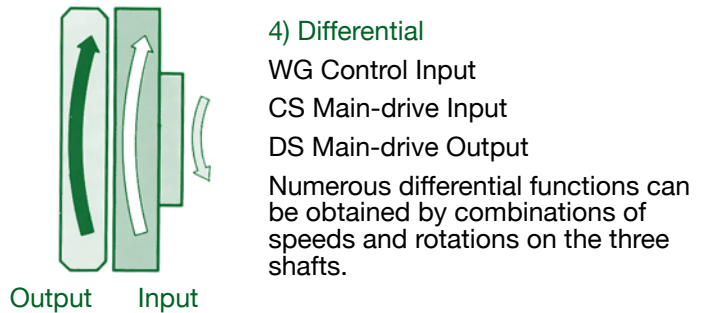
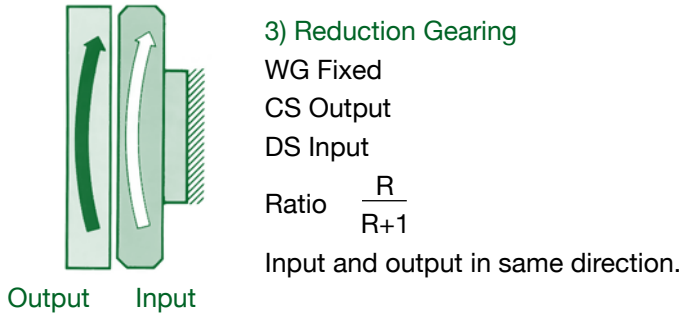
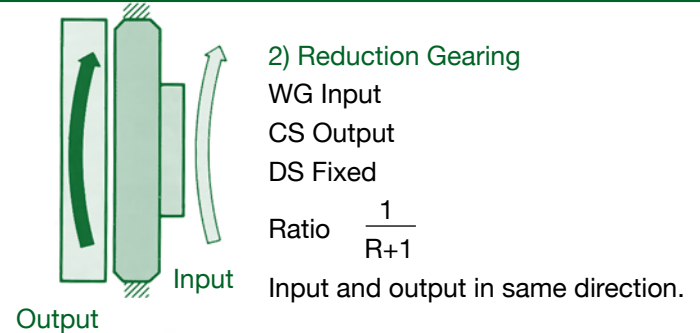
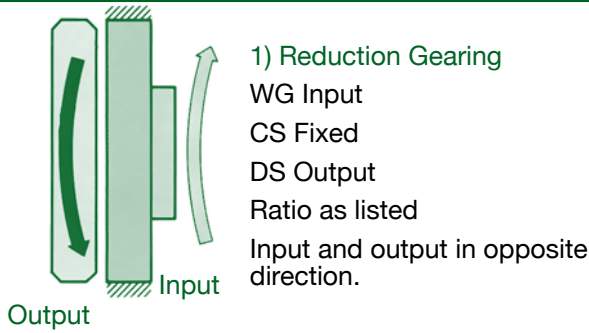

Typical Installation

FB “pancake” type component sets are easier to use than conventional gearing. All that is required is suitable bearing support for the input and output shaft, and a means of fixing the circular spline against rotation.

The simplicity of FB component sets is demonstrated in the typical arrangements shown below.

- 1. Wave Generator
- 2. Flexspline
- 3. Circular Spline
- 4. Dynamic Spline
- 5. Motor
- 6. Input Shaft or Motor Shaft
- 7. Output Shaft

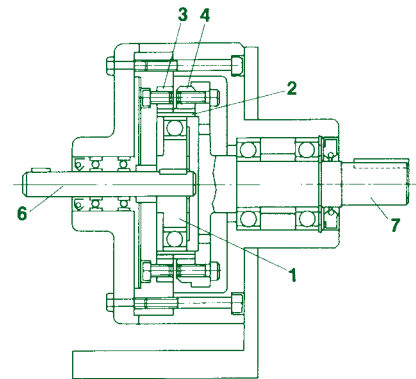
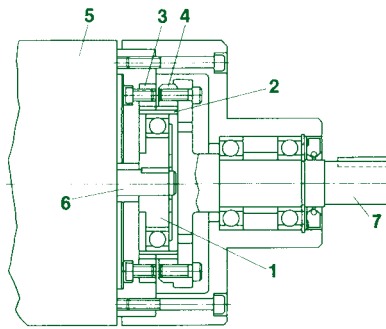

Ordering Information

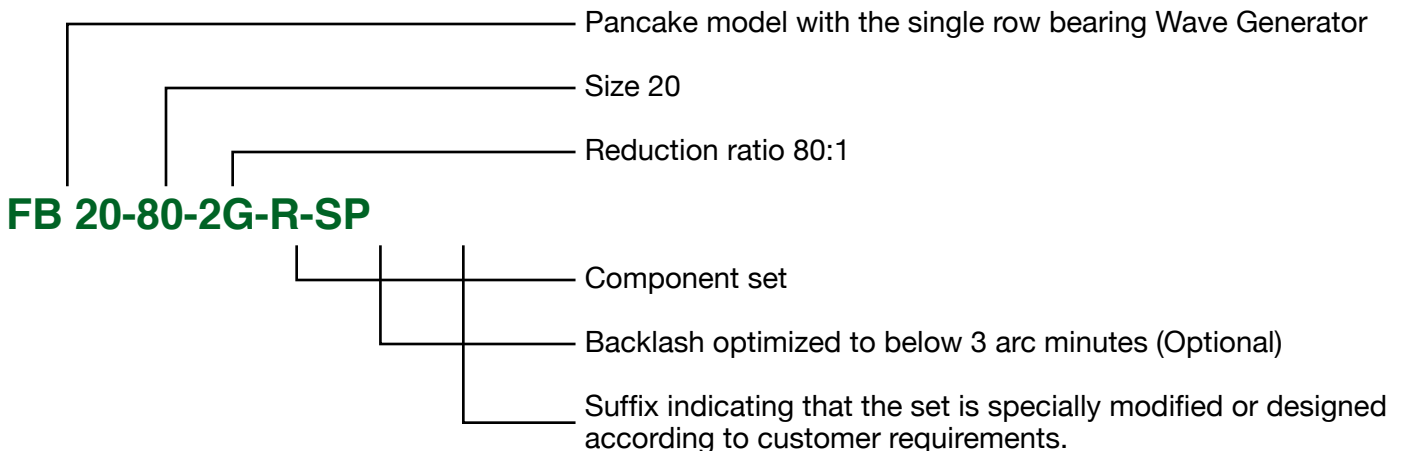

Dimensions

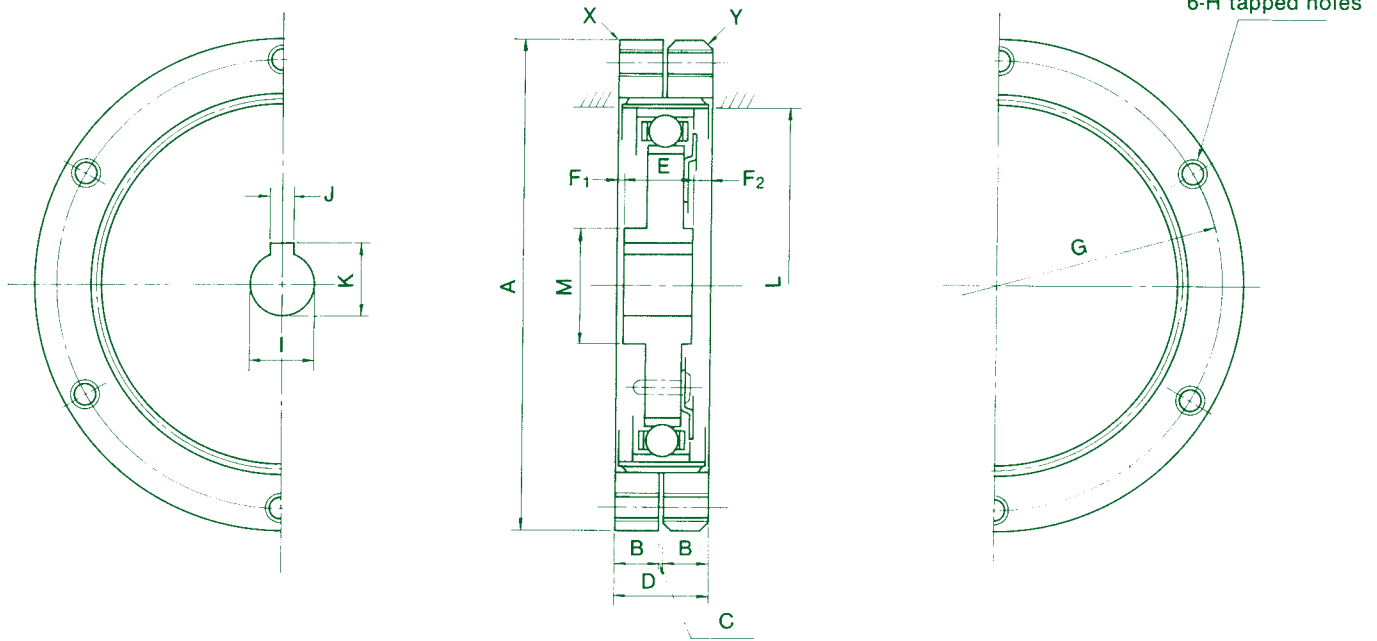

FB-14

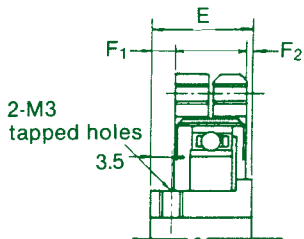

FB-20

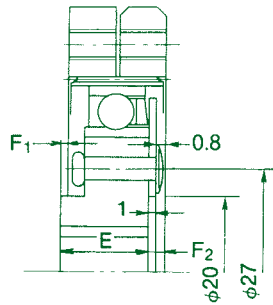

FB-50

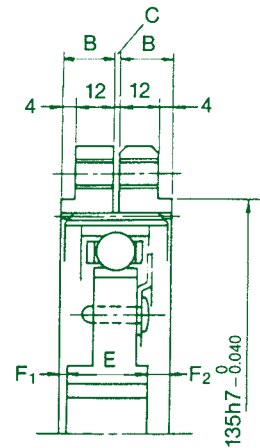

FB	A (g7)	B	C	D	E	F ₁	F ₂	G	H	I		J (JS9)	K	L	M	N	X	Y	Wt	
										(H7)	Max								lb	kgf
14	50 ^{-0.009} _{-0.034}	5	0.5	10.5	15.0	3.75	0.75	44	M3	6 ^{+0.012} ₀	8	—	—	29	14	—	0.2	1.0	0.2	0.1
20	70 ^{-0.010} _{-0.040}	6	0.5	12.5	11.4	0.95	2.05	60	M4	9 ^{+0.015} ₀	12	3±0.0125	10.4	42	20	—	0.2	1.0	0.2	1.0
25	85 ^{-0.012} _{-0.047}	8	0.5	16.5	12.8	0.35	3.35	75	M5	14 ^{+0.018} ₀	15	5±0.0150	16.3	53	26	0.9	0.2	1.5	1.1	0.5
32	110 ^{-0.012} _{-0.047}	10	0.5	20.5	15.6	0.95	3.95	100	M6	14 ^{+0.018} ₀	15	5±0.0150	16.3	69	26	0.8	0.2	1.5	2.2	1.0
40	135 ^{-0.014} _{-0.054}	13	1	27.0	19.4	1.80	5.80	120	M8	14 ^{+0.018} ₀	20	5±0.0150	16.3	84	32	1.2	0.4	2.0	4.0	1.8
50	170 ^{-0.014} _{-0.054}	16	1	33.0	23.2	2.90	6.90	150	M10	19 ^{+0.021} ₀	20	6±0.0150	21.8	105	32	1.1	0.4	2.0	6.4	2.9

Maximum housing I.D. for Flexspline axial containment is L. The surface hardness in the region where the Flexspline abuts the housing is recommended to be HRC 29–34.

Performance Ratings

FB	Gear Ratio	Rated Input Rotational Speed	Rated Torque at 2000rpm		Repeated Peak Torque		Max. Average Load Torque		Max. Momentary Torque		Max. Input Speed rpm		Limit for Average Input Speed, rpm		Moment of Inertia**		Backlash*** arc min.	
			rpm	N.m	In.lb	N.m	In.lb	N.m	In.lb	N.m	In.lb	Oil Lub.	Grease Lub.	Oil Lub.	Grease Lub.	kg-cm ²	lb-in ²	Optimized
14	50	2000	2.6	23	3.2	28	3.2	28	6.9	61	6000	3600	4000	2500	0.033	0.011	3	32
	88		4.9	43	7.8	69	7.8	69	15.7	139*								
	100		5.9	52	9.8	87	9.8	87	15.7	139*								
	110		5.9	52	9.8	87	9.8	87	15.7	139*								
20	50	2000	14	124	18	159	18	159	34	301	6000	3600	3600	2500	0.14	0.048	3	32
	80		17	150	21	186	21	186	35	310								
	100		22	195	26	230	25	221	47	416								
	128		24	212	33	292	25	221	58	513								
	160		24	212	38	336	25	221	59	522*								
25	50	2000	23	204	30	266	30	266	54	478	5000	3600	3000	2500	0.36	0.12	3	30
	80		31	274	39	345	39	345	70	620								
	100		39	345	52	460	52	460	91	805								
	120		39	345	61	540	61	540	94	832*								
	160		39	345	76	673	61	540	86	761*								
32	50	2000	44	389	60	531	60	531	108	956	4500	3600	2500	2300	1.3	0.44	3	24
	78		63	558	75	664	75	664	127	1124								
	100		82	726	98	867	98	867	176	1558								
	131		82	726	137	1212	118	1044	235	2080*								
	157		82	726	157	1389	118	1044	235	2080*								
40	50	2000	88	779	118	1044	118	1044	216	1912	4000	3300	2000	2000	3.4	1.2	3	24
	80		118	1044	147	1301	147	1301	265	2345								
	100		157	1389	186	1646	186	1646	343	3036								
	128		167	1478	235	2080	235	2080	372	3292*								
	160		167	1478	284	2513	274	2425	353	3124*								

* Torque value limited by "Ratceting".

** Moment of Inertia: $1 = 1/4 GD^2$.

*** Backlash measured at output with the input locked, maximum value.

Lubrication

Oil lubrication ratings are based on Molub Alloy gear Oil No. 80. See table for recommended oil level and volume for horizontal shaft mounting.

For vertical mounting the recommended level is at the wave generator bearing ball centerline or midpoint of the drive.

FB		14	20	25	32	40	50
Oil Level Below Drive Centerline	mm	7.6	12.7	15.2	17.8	23.0	30.5

Grease lubricated ratings are based on Harmonic Grease HC-1, which has been specially developed for Harmonic Drive™ FB product. Alternate lubricants include Molub Alloy Grease No. 2, Shell Alvania EP 1 and their equivalents.

For retention of grease within the tooth mesh area and the ball bearing, it is recommended that the L dimension (see FB Dimensions, page 4) be extended further inward to at least S.

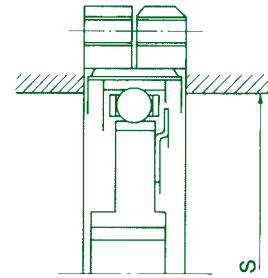

FB	14	20	25	32	40	50
S	26	38	48	63	76	95

Installation

The Dynamic Spline is distinguished by its chamfered outer edge. FB Component Sets may be operated in any attitude. Recommended installed relationships are shown below:

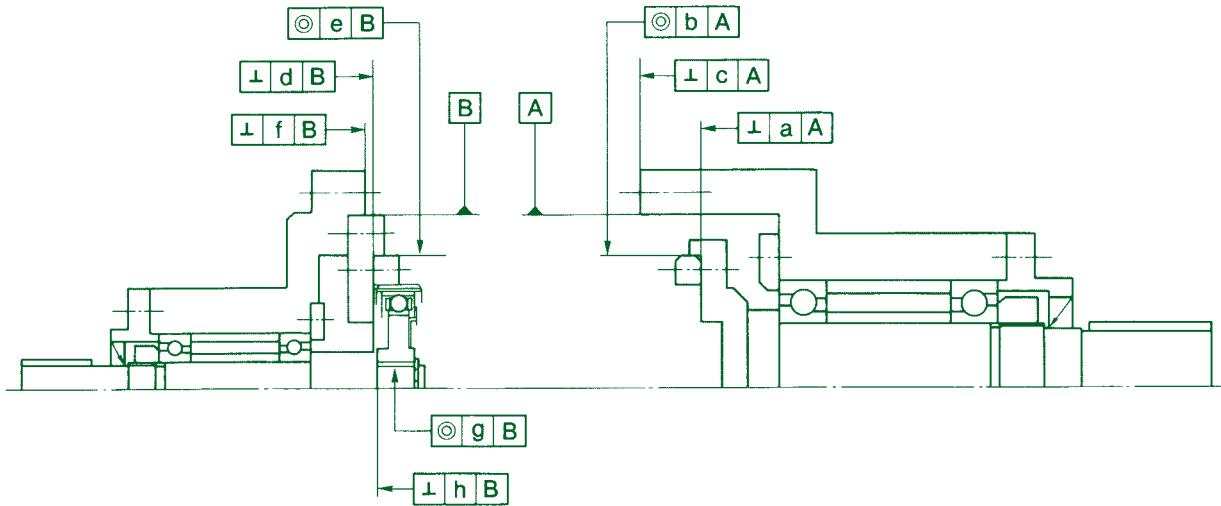

Housing Tolerance

FB	a	b	c	d	e	f	g	h
14	0.013	0.015	0.016	0.013	0.015	0.016	0.011	0.007
20	0.017	0.016	0.020	0.017	0.016	0.020	0.013	0.010
25	0.024	0.016	0.029	0.024	0.016	0.029	0.016	0.012
32	0.026	0.017	0.031	0.026	0.017	0.031	0.016	0.012
40	0.026	0.019	0.031	0.026	0.019	0.031	0.017	0.012
50	0.028	0.024	0.034	0.028	0.024	0.034	0.021	0.015

Efficiency

Efficiency varies depending on input speed, ratio, load level, temperature, and type of lubrication. The effects of these factors are illustrated in the curves shown below.

FB Efficiency vs. Ratio, Temperature, and Lubricant (At Rated Torque)

Input Speed 500 rpm

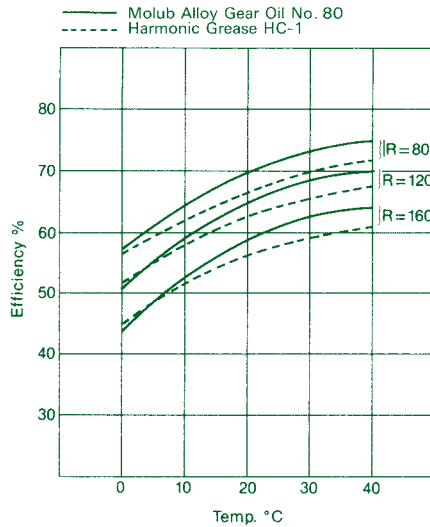

Input Speed 3400 rpm

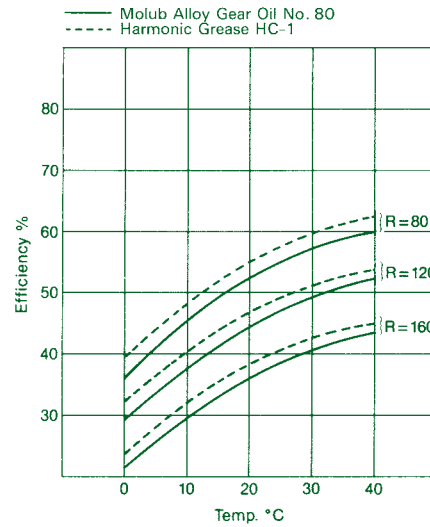

Input Speed 1700 rpm

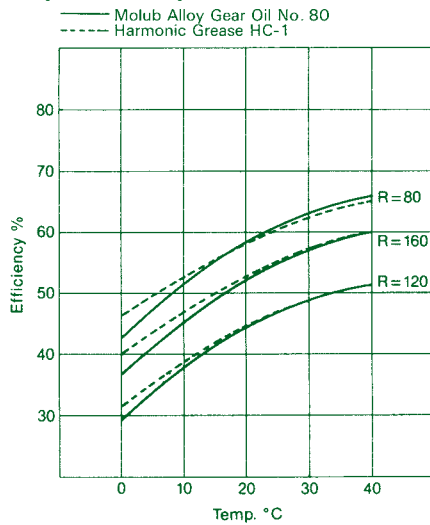

No-Load Running Torque, Starting Torque, and Backdriving Torque

FB		14	20	25	32	40	50
NL Running Torque @ 1500 rpm	Ncm	3~8	5~11	6~30	15~40	20~65	60~150
	oz-in	4~11	7~15	8~42	20~56	28~90	83~210
Starting Torque	Ncm	0.5~3	0.8~4	2~7	3~10	5~30	10~60
	oz-in	0.7~4	1~6	3~10	4~14	7~42	14~83
Backdriving Torque	Nm	0.8~7	2~10	3~38	4~40	8~60	20~110
	lb-in	6~60	17~87	26~330	35~350	70~520	170~950

Values quoted are based on actual tests with the component sets assembled in housings, and takes into consideration friction resistance of oils seals, and churning of oil.

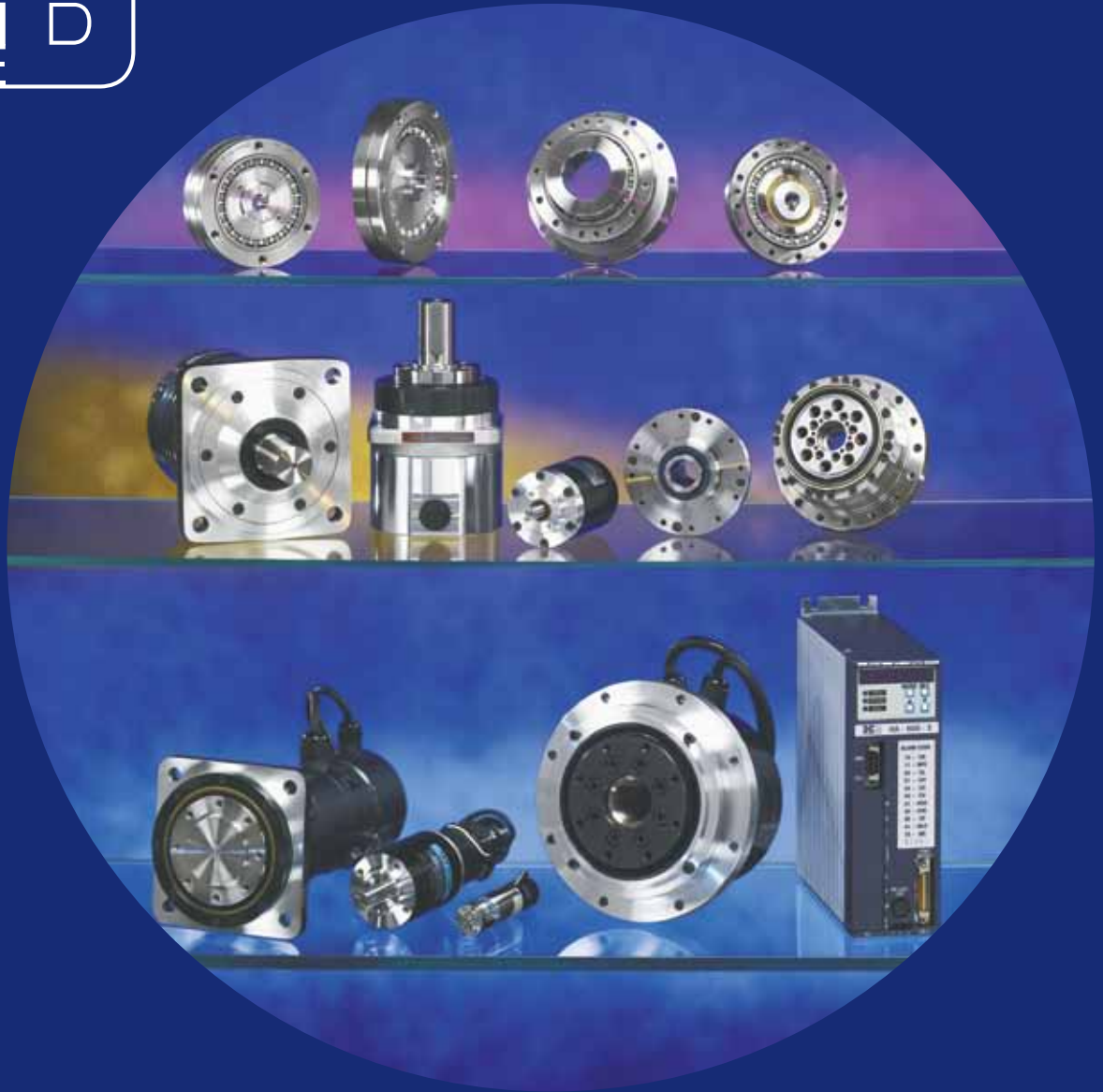

Harmonic Drive LLC

Boston US Headquarters

247 Lynnfield Street
Peabody, MA 01960

New York Sales Office:

Harmonic Drive LLC
100 Motor Parkway
Suite #116
Hauppauge, NY 11788

San Jose Sales Office:

Harmonic Drive LLC
2033 Gateway Place
Suite #639
San Jose, CA 95110

T: 800-921-3332

F: 978-532-9406

www.HarmonicDrive.net

Worldwide Locations:

Harmonic Drive Systems, Inc.
Minamiohi 6-25-3, Shinagawa-ku
Tokyo 140, Japan

Harmonic Drive AG
Hoenbergstr, 14
Limburg/Lahn, D-65555 Germany

Harmonic Drive is a trademark of Harmonic Drive LLC.



Rev 08-11