

Harmonic Drive[®]

MECHATRONICS

AC Servo Actuator

compatible with Panasonic MINAS A6 series

SHA-P series manual

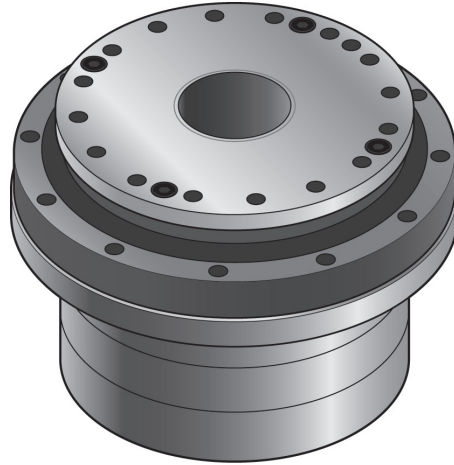



Introduction

Thank you for purchasing our SHA-P series AC Servo Actuator.

Wrong handling or use of this product may result in unexpected accidents or shorter life of the product. Read this document carefully and use the product correctly so that the product can be used safely for many years.

Product specifications are subject to change without notice for improvement purposes.

Company names and product names in this document are generally registered trademarks or trademarks of their respective companies.

Keep this manual in a convenient location and refer to it whenever necessary in operating or maintaining the units.



The end user of the actuator should have a copy of this manual.

SAFETY GUIDE

To use this actuator safely and correctly, be sure to read SAFETY GUIDE and other parts of this document carefully and fully understand the information provided herein before using the actuator.

NOTATION

Important safety information you must note is provided herein. Be sure to observe these instructions.

 WARNING	Indicates a potentially hazardous situation, which, if not avoided, could result in death or serious personal injury.
 CAUTION	Indicates a potentially hazardous situation, which, if not avoided, may result in minor or moderate personal injury and/or damage to the equipment.
Caution	Indicates what should be performed or avoided to prevent non-operation or malfunction of the product or negative effects on its performance or function.

LIMITATION OF APPLICATIONS

The equipment listed in this document may not be used for the applications listed below:

- Space equipment
- Automobile, automotive parts
- Aircraft, aeronautic equipment
- Amusement equipment, sport equipment, game machines
- Nuclear equipment
- Machine or devices acting directly on the human body
- Household apparatus
- Instruments or devices to transport or carry people
- Vacuum equipment
- Apparatus or devices used in special environments

If the above list includes your intending application for our products, please consult us.



Safety measures are essential to prevent accidents resulting in death, injury or damage of the equipment due to malfunction or faulty operation.

SAFETY NOTE

ITEMS YOU SHOULD NOTE WHEN USING THE ACTUATOR

● CAUTIONS RELATED TO THE DESIGN



Always use under followings conditions.

The actuator is designed to be used indoors. Observe the following conditions:

- Ambient temperature: 0 to 40 °C
- Ambient humidity: 20 to 80 %RH (Non-condensation)
- Vibration: Max 25 m/s²
- No contamination by water, oil
- No corrosive or explosive gas

Follow exactly the instructions in the relating manuals to install the actuator in the equipment.

- Ensure exact alignment of the actuator center and the center of the corresponding machine by following the manual.
- Failure to observe this caution may lead to vibration, resulting in damage of output elements.

● CAUTIONS FOR USAGE



Keep limited torques of the actuator.

- Keep limited torques of the actuator.
- Be aware, that if arms attached to output element hits by accident an solid, the output element may be uncontrollable.

Never connect cables directly to a power supply socket.

- Each actuator must be operated with a proper servo amplifier.
- Failure to observe this caution may lead to injury, fire or damage of the actuator.

Do not apply impacts and shocks

- The actuator directly connects with the encoder so do not use a hammer during installation.
- Failure to observe this caution could damage the encoder and may cause uncontrollable operation.

Avoid handling of actuators by cables.

- Failure to observe this caution may damage the wiring, causing uncontrollable or faulty operation.

ITEMS YOU SHOULD NOTE WHEN USING THE SERVO AMPLIFIER

- Read the related manuals to ensure safe operation. For details on the related manuals, refer to the [Related manual] (P6).
- Before usage, ensure you read the "Safety Guide AC Servo Motor & Amplifier MINAS A6 Series" operation manual.
Please download the operation manual from the Panasonic Corporation website.
<http://industrial.panasonic.com/jp/products/motors-compressors/fa-motors>
- OPERATIONAL PRECAUTIONS

**Never change any wiring while the power is active.**

Make sure that the power is not active before servicing the products. Failure to observe this caution may result in an electric shock or uncontrollable operation.

Do not touch the terminals for at least 15 minutes after turning OFF the power supply.

- Even after the power supply is turned OFF, electric charge remains in the servo amplifier. In order to prevent electric shock, perform inspections 15 minutes or more after the power supply is turned OFF.
- When installing, make sure that the inner electronic components are hard to reach.

DISPOSAL**All products or parts have to be disposed of as industrial waste.**

Since the case or the box of drivers have a material indication, classify parts and dispose them separately.

Contents

SAFETY GUIDE	1
NOTATION	1
LIMITATION OF APPLICATIONS.....	1
SAFETY NOTE	2
Contents	4
Related manual	6
Conformance to overseas standards.....	7

Chapter 1 Outlines

1-1 Outlines	1-1
1-2 Model	1-3
1-3 Combinations with servo amplifier and extension cables	1-4
1-4 Specifications	1-6
1-5 Motor shaft holding brake.....	1-16
1-6 External dimensions.....	1-19
1-7 Mechanical accuracy.....	1-30
1-8 Positional accuracy	1-32
Uni-directional positional accuracy	1-32
Repeatability (CG type)	1-33
Reverse positional accuracy (CG type).....	1-33
1-9 Encoder specifications	1-35
1-10 Rigidity	1-37
Moment stiffness	1-37
Torsional rigidity.....	1-38
1-11 Rotation direction.....	1-40
1-12 Shock resistance.....	1-41
1-13 Resistance to vibration	1-42
1-14 Operable range	1-43
1-15 Cable specifications	1-55
Motor cable specifications	1-55
Encoder cable specifications	1-56

Chapter 2 Selection guidelines

2-1 SHA-P series selection.....	2-1
Allowable load inertia moment.....	2-1
2-2 Change in load inertia moment	2-6
2-3 Verifying and examining load weights	2-7
Maximum load moment load.....	2-8
Verifying life.....	2-8
Verifying static safety coefficients	2-10
2-4 Verifying operating conditions	2-11
Examining actuator rotation speed	2-11
Calculating and examining load inertia moment.....	2-11
Load torque calculation	2-12
Acceleration time and deceleration time	2-13
Examining effective torque and average rotation speed	2-14

Chapter 3 Installing SHA-P actuator

3-1 Product Verification	3-1
Verification steps	3-1
3-2 Notices on handling.....	3-2
Installation and transmission torque	3-2
Precautions on installation.....	3-4
Use of positioning pins	3-5
Surface treatments	3-5
3-3 Location and installation.....	3-6
Installing environment.....	3-6
Installation	3-7

Chapter 4 Options

4-1 Options.....	4-1
With near origin and end limit sensors (option code: L)	4-1
Cable taken out from side face (option code: Y)	4-1
With stand (CG type, option code: V)	4-2
Extension cables	4-4

Chapter 5 Appendix

A-1 Unit conversion.....	A-1
A-2 Calculating inertia moment	A-3
Formula of mass and inertia moment	A-3

Related manual

The table below lists related manual. Check each item as necessary.

Title	Document No.	Description	Obtaining method
Modbus communication and Block operation Specification	No.SX-DSV03033	MINAS A6 Modbus communication specifications and block operation function specifications are explained.	Can be downloaded from the Panasonic Corporation website.
Functional Specification	No.SX-DSV02910	Servo amplifier MINAS A6 series functions are explained.	
Realtime Express (RTEX) Functional Specification	No.SX-DSV03027	Servo amplifier MINAS A6N series functions are explained.	
Realtime Express (RTEX) Communication Specification	No.SX-DSV03028	The specifications of the network interface "Realtime Express" RTEX, which connects the servo amplifier MINAS A6N series to the host device, are explained.	
EtherCAT Functional Specification	No.SX-DSV03215	Servo amplifier MINAS A6B series functions are explained.	
EtherCAT Communication Specification	No.SX-DSV03216	The specifications of the network interface EtherCAT, which connects the servo amplifier MINAS A6B series (slave) to the host device (master), are explained.	

Conformance to overseas standards

SHA-P series actuator conforms to following overseas standards.

UL Standard	UL1004-1, UL1004-6 (File No. E243316)
CSA Standard	C22.2 No.100
European Low Voltage EC Directives	EN60034-1, EN60034-5

UL nameplate sticker

The following specifications of SHA-P series actuators are shown based on the UL1004-1, UL1004-6 (File No. E243316) standards.

Nameplate field	Explanation
(1)	Output [W] at point A on the graph below
(2)	Voltage [V] between motor wires at point A on the graph below
(3)	Allowable continuous current [A]
(4)	Rotation speed [r/min] at point A on the graph below
(5)	Current fundamental frequency [Hz] at point A on the graph below
(6)	Allowable range temperature [°C]
(7)	Number of phase

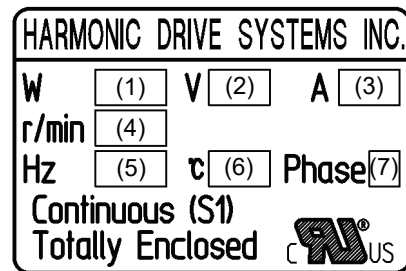

UL nameplate sticker

Radiation plate: 350×350×18 [mm]

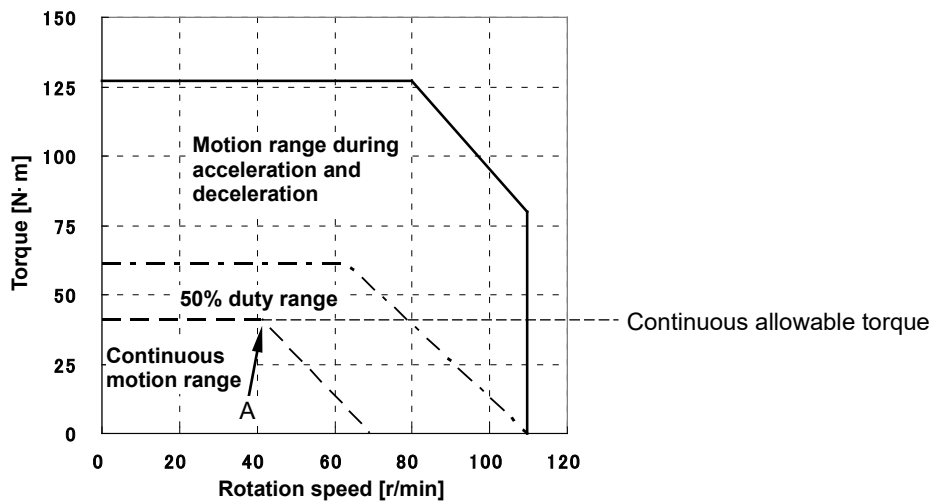

The nameplate values of various models are shown below.

SG type

Model		SHA20P					SHA25P				
		51	81	101	121	161	51	81	101	121	161
(1) Output at point A	W	99	109	109	106	86	175	203	207	178	127
(2) Voltage at point A	V	113	117	117	119	122	115	122	125	125	120
(3) Allowable continuous current	A	2.1	2.0	2.0	1.9	1.6	3.0	3.0	2.9	2.6	2.1
(4) Speed at point A	r/min	44	30	24	21	17	41	29	24.5	21	15
(5) Frequency at point A	Hz	187	203	202	212	228	174	196	206	212	201
(6) Allowable range temperature	°C	40									
(7) Number of phase	—	3									

Model		SHA32P					SHA40P					SHA45P				
		51	81	101	121	161	51	81	101	121	161	51	81	101	121	161
(1) Output at point A	W	328	369	373	308	233	487	564	570	560	480	456	534	543	551	537
(2) Voltage at point A	V	110	114	118	116	115	109	115	115	116	122	103	108	108	109	112
(3) Allowable continuous current	A	6.0	6.0	5.7	5.0	4.1	9.0	9.0	9.0	8.8	7.2	10.0	10.0	10.0	10.0	9.2
(4) Speed at point A	r/min	34	23	20	16.5	12.5	29	20.5	16.5	14	12	25	17.6	14.3	12	9.8
(5) Frequency at point A	Hz	145	155	168	166	168	123	138	139	141	161	107	119	120	121	132
(6) Allowable range temperature	°C	40														
(7) Number of phase	—	3														

Model		SHA58P				SHA65P			
		81	101	121	161	81	101	121	161
(1) Output at point A	W	897	948	863	731	964	963	958	802
(2) Voltage at point A	V	99	101	101	107	92	92	96	100
(3) Allowable continuous current	A	17.7	17.8	16.4	13.4	22.0	21.9	20.1	16.3
(4) Speed at point A	r/min	12	10	8.5	7.2	10	8	7.4	6.2
(5) Frequency at point A	Hz	130	135	137	155	108	108	119	133
(6) Allowable range temperature	°C	40							
(7) Number of phase	—	3							

CG type

Item	Model	SHA20P					SHA25P				
		50	80	100	120	160	50	80	100	120	160
(1)Output at point A	W	97	108	108	106	85	177	201	204	174	127
(2)Voltage at point A	V	112	116	116	119	122	115	121	123	123	119
(3)Allowable continuous current	A	2.1	2.1	2.1	2.0	1.7	3.0	3.0	3.0	2.6	2.1
(4)Speed at point A	r/min	44	29.5	24	21	17	42	29	24	20.5	15
(5) Frequency at point A	Hz	183	197	200	210	227	175	193	200	205	200
(6) Allowable range temperature	°C	40									
(7)Number of phase	—	3									

Item	Model	SHA32P					SHA40P				
		50	80	100	120	160	50	80	100	120	160
(1)Output at point A	W	321	372	373	308	233	493	558	568	568	488
(2)Voltage at point A	V	109	114	117	116	115	109	114	115	116	123
(3)Allowable continuous current	A	6.0	6.0	5.7	5.0	4.1	9.0	9.0	9.0	8.8	7.2
(4)Speed at point A	r/min	34	23.5	20	16.5	12.5	30	20.5	16.6	14.2	12.2
(5)Frequency at point A	Hz	142	157	167	165	167	125	137	138	142	163
(6)Allowable range temperature	°C	40									
(7)Number of phase	—	3									

Chapter 1

Outlines

This chapter explains the features, functions and specifications of the actuator.

1-1 Outlines	1-1
1-2 Model	1-3
1-3 Combinations with servo amplifier and extension cables	1-4
1-4 Specifications	1-6
1-5 Motor shaft holding brake	1-16
1-6 External dimensions	1-19
1-7 Mechanical accuracy	1-30
1-8 Positional accuracy	1-32
1-9 Encoder specifications	1-35
1-10 Rigidity	1-37
1-11 Rotation direction	1-40
1-12 Shock resistance	1-41
1-13 Resistance to vibration	1-42
1-14 Operable range	1-43
1-15 Cable specifications	1-55

1-1 Outlines

The SHA-P series comprises AC Servo Actuators that provide high torque and highly accurate rotary operation that can be controlled with RTEX or EtherCAT by combining the SHA series with the Panasonic AC servo amplifier MINAS A6 series. AC Servo Actuator models 20 through 65 comprise a speed reducer HarmonicDrive® for precision control combined with a flat AC servo motor. There are 2 types of speed reducers: SG type with SHG series incorporated, and CG type with CSG series incorporated. They are an advanced version of current FHA series AC Servo Actuators having a flat, hollow structure. They represent further evolution from the previous flat, hollow FHA series servo actuators.

One key feature of SHA-P series actuators is their compact size. The outer diameter has been reduced, while the maximum torque/volume ratio is approximately double that of any conventional actuator. The hollow structure maintains the same size as conventional actuators. A through-hole is provided at the center of the actuator, through which wirings, air pipes, and even laser beams can be passed to supply power and give/receive signals to moving parts of machines and devices.

SHA-P series actuators play an important role in driving various factory automation (FA) equipment, such as robot joints, alignment mechanisms for semi-conductor and LCD devices, ATC of metal-cutting machines, printing machine roller drive, etc.

◆ Doubled torque/volume ratio

The incorporation of a speed reducer HarmonicDrive® for precision control SHG series or CSG series has achieved an approximately 20 % smaller external diameter when compared with our conventional products. Accordingly, the maximum torque/volume ratio has increased to approximately double the ratio of any conventional actuator. Based on the maximum torque, you can select a model of one smaller size. Also, output torque at the same volume/weight is very high compared to when a direct drive motor is used. This is another reason why SHA-P series has a great advantage.

◆ More variety in large size

7 models are available for SG type including those (#58, #65) accommodating high torque up to 3400 N·m - the range not heretofore supported. The wide lineup also includes models supporting intermediate reduction ratios of 1/81, 1/121, and so on. CG type has 4 models available with 5 reduction ratios of 1/50 to 1/160.

◆ Modular design

The components of SHA-P series, such as speed reducers, output shaft bearing, motor, brake and encoder, are arranged based on modular design. We can also custom-design a model meeting your specific requirements, so please contact your HDS sales representative.

Also, with the PMA Series Flat Hollow Shaft AC Servo Motors, a motor can be purchased separately. For details, refer to "PMA series manual".

◆ Comes standard with a 17-bit magnetic absolute encoder

The newly developed AC servo motors are equipped with HDS's original highly reliable 17-bit magnetic absolute encoder* with safety function. The serial communication requires fewer cables.

The encoder also constantly compares two sets of detected angles. If any abnormality is found, the encoder's built-in failsafe function outputs a signal to the host system. This certainly helps you build a safe system.

* Model No.20 is equipped with an optical encoder.

◆ Combination with MINAS A6 amplifiers is now possible.

Combination with Panasonic MINAS A6 / A6N / A6B amplifiers is now possible. It can be controlled using RTEX or EtherCAT high-speed networks. Differences in encoding formats means that start-up may take longer, therefore please change parameter Pr 6.18 [Power ON wait time] (default 0→3.5). This change is not necessary when size No 20 is used.

◆ CG type with an improved output shaft deflection accuracy is added to the product lineup

After reviewing the output rotary unit structure, the higher accuracy of the surface runout and shaft deflection has been achieved. This is ideal for use with index tables.

1-2 Model

Model names for SHA-P series actuators and how to read the symbols are explained below.

Model example:

SHA	32	P	101	SG	-	B	12	A	200	-	34	S	17b	B	-	C	-	A6	-	SP	
(1)	(2)	(3)	(4)	(5)	-	(6)	(7)	(8)	(9)	-	(10)	(11)	(12)	(13)	-	(14)	(15)	-	(16)	-	(17)

- (1) Model: AC Servo Actuator SHA-P series
- (2) Size Nos: 20, 25, 32, 40, 45, 58, 65: SG type
20, 25, 32, 40: CG type
- (3) Version symbol
- (4) Reduction ratio (indicated by R in 1/R format)

SHG		CSG	
51	1/51	50	1/50
81	1/81	80	1/80
101	1/101	100	1/100
121	1/121	120	1/120
161	1/161	160	1/160

- (5) Speed reducer type
- | | |
|----|---|
| SG | HarmonicDrive® speed reducer SHG series |
| CG | HarmonicDrive® speed reducer CSG series |

- (6) Motor version symbol
- | | |
|---|---------------------|
| A | Size Nos 58, 65 |
| B | Size Nos 25, 32, 40 |
| C | Size No. 20 |
| D | Size No. 45 |

- (7) Motor size
- | | |
|----|-----------------|
| 08 | Size No. 20 |
| 09 | Size No. 25 |
| 12 | Size No. 32 |
| 15 | Size No. 40 |
| 16 | Size No. 45 |
| 21 | Size Nos 58, 65 |

- (8) Brake
- | | |
|---|---------------|
| A | Without brake |
| B | With brake |

- (9) Motor input voltage
- | | |
|-----|-------|
| 200 | 200 V |
|-----|-------|

- (10) Encoder format
- | | |
|----|--|
| 14 | MINAS-supported format compliant
Transmission rate: 2.5 Mbps, 1-on-1 connection, with backup capacitor |
| 34 | MINAS-supported format compliant
Transmission rate: 2.5 Mbps, 1-on-1 connection, without backup capacitor |
- (Encoder format "14" is compatible with SHA20P only.)

- (11) Encoder type
- | | |
|---|--------------------------|
| S | Multi-turn absolute type |
|---|--------------------------|

- (12) Encoder resolution
- | | |
|-----|-----------------------------------|
| 17b | 17 bit (131072 pulses/revolution) |
|-----|-----------------------------------|

- (13) Encoder phase angle: Phase difference between induced voltage in motor phase U and absolute origin
- | | |
|---|-----------|
| B | 30 degree |
|---|-----------|

- (14) Connector specification
- | | |
|---|-------------------------|
| C | With standard connector |
| N | Without connector |

- (15) Option symbol
- | | |
|---|--|
| L | With near origin and end limit sensors |
| V | With stand (CG type only) |
| Y | Cable taken out from side |
- (Please contact us for option-compatible combinations.)

- (16) Combined amplifier symbol
- | | |
|----------------|------------------|
| No description | Combined with A5 |
| A6 | Combined with A6 |
- (For information on combinations with MINAS A5 servo amplifiers, refer to the separate manual.)

- (17) Special specification
- | | |
|----------------|-------------------------------|
| No description | Standard product |
| SP | Special specification product |

1-3

Combinations with servo amplifier and extension cables

1

Outlines

The combinations of SHA-P actuators, MINAS A6 servo amplifiers, and extension cables are as follows. SHA20P/25P/32P can be used with single-phase 200 VAC or 3-phase 200 VAC. SHA40P/45P/58P/65P can be used with 3-phase 200 VAC.

SG type

Actuator model	Model No.	SHA20P					SHA25P					SHA32P					SHA40P							
		Speed ratio	51	81	101	121	161	51	81	101	121	161	51	81	101	121	161	51	81	101	121	161		
Servo amplifier model	MBDL□25■	○	○	○	○	○						○												
	MCDL□35■						○	○	○	○							○							
	MDDL□45■														○									
	MDDL□55■													○	○	○				○	○	○	○	○
	MEDL□83■																	○						
	MEDL□93■																							
	MFDL□A3■																							
MFDL□B3■																								
Extension cables (option)	Motor wire	EWD-MB**-A06-TN-P																						
	Encoder wire	MFECA0**-0EAE (With battery box)																						

Actuator model	Model No.	SHA45P					SHA58P				SHA65P				
		Speed ratio	51	81	101	121	161	81	101	121	161	81	101	121	161
Servo amplifier model	MBDL□25■														
	MCDL□35■														
	MDDL□45■														
	MDDL□55■					○									
	MEDL□83■	○	○	○	○										
	MEDL□93■								○						
	MFDL□A3■						○	○	○						○
MFDL□B3■										○	○	○			
Extension cables (option)	Motor wire	EWD-MB**-A06-TN-P					EWD-MB**-D09-TMC-P								
	Encoder wire	MFECA0**-0EAE (With battery box)					MFECA0**-0ETE (With battery box)								

CG type

Actuator model	Model No.	SHA20P					SHA25P					SHA32P					SHA40P							
		Speed ratio	50	80	100	120	160	50	80	100	120	160	50	80	100	120	160	50	80	100	120	160		
Amplifier model	MBDL□25■	○	○	○	○	○						○												
	MCDL□35■						○	○	○	○							○							
	MDDL□45■														○									
	MDDL□55■													○	○	○				○	○	○	○	○
	MEDL□83■																	○						
	MEDL□93■																							
	MFDL□A3■																							
MFDL□B3■																								
Extension cables (option)	Motor wire	EWD-MB**-A06-TN-P																						
	Encoder wire	MFECA0**-0EAE (With battery box)																						

** in the extension cable model for the motor and encoder wire indicates the cable length:

03 = 3 m, 05 = 5 m, 10 = 10 m, 20 = 20 m

For details on encoder wires, contact Panasonic Corporation customer support.

"□" and "■" in the servo amplifier model are the function classifications for safety functions and interface specifications.

See below for details.

Symbol	Symbol	Specification
□	N	Without safety function
	T	With safety function

Symbol	Symbol	Interface specification	Function classification
■	SE	Analog/Pulse	Position control type
	SG		General purpose communication type
	SF		Multi-function type
	NE	RTEX	Standard type
	NF		Multi-function type
	BE	EtherCAT	Standard type
	BF		Multi-function type

1-4 Specifications

The specifications of SHA-P series actuators are explained.

SG type

Item	Model	SHA20P					
		51	81	101	121	161	
Max. torque ^{*1}	N·m	73	96	107	113	120	
	kgf·m	7.4	9.8	10.9	11.5	12.2	
Allowable continuous torque ^{*1*2}	N·m	21	35	43	48	48	
	kgf·m	2.1	3.6	4.4	4.9	4.9	
Max. rotational speed ^{*1}	r/min	117.6	74.1	59.4	49.6	37.3	
Torque constant ^{*1}	N·m/A	16.5	27	33	40	53	
	kgf·m/A	1.7	2.7	3.4	4.1	5.4	
Max. current ^{*1}	A	6.0	4.9	4.5	4.0	3.4	
Allowable continuous current ^{*1*2}	A	2.1	2.0	2.0	1.9	1.6	
EMF constant ^{*3}	V/(r/min)	1.9	3.0	3.7	4.5	5.9	
Phase resistance (20 °C)	Ω	1.4					
Phase inductance	mH	2.5					
Inertia moment (without brake)	GD ² /4	kg·m ²	0.23	0.58	0.91	1.3	2.3
	J	kgf·cm·s ²	2.4	6.0	9.3	13	24
Inertia moment (with brake)	GD ² /4	kg·m ²	0.26	0.65	1.0	1.4	2.6
	J	kgf·cm·s ²	2.6	6.6	10	15	26
Reduction ratio	—	1:51	1:81	1:101	1:121	1:161	
Permissible moment load	N·m	187					
	kgf·m	19.1					
Moment stiffness	N·m/rad	25.2×10 ⁴					
	kgf·m/arc-min	7.5					
Uni-directional positional accuracy	Sec.	60	50	50	50	50	
Encoder type	—	Absolute encoder					
Encoder resolution	Single-turn detector	2 ¹⁷ (131072)					
	Multi-turn detector ^{*5}	2 ¹⁶ (65536)					
Output shaft resolution	Pulse/rev	6684672	10616832	13238272	15859712	21102592	
Mass (without brake)	kg	2.0					
Mass (with brake)	kg	2.1					
Environmental conditions ^{*6}	Operating temperature: 0 to 40 °C/Storage temperature: -20 to 60 °C Operating humidity/storage humidity: 20 to 80 %RH (no condensation) Resistance to vibration ^{*4} : 25 m/s ² (frequency: 10 to 400 Hz) Shock resistance ^{*4} : 300 m/s ² No dust, no metal powder, no corrosive gas, no inflammable gas, no oil mist To be used indoors, no direct sunlight Altitude: less than 1000 m above sea level						
Motor insulation	Insulation resistance: 100 MΩ or more (by 500 VDC insulation tester) Dielectric strength: 1500 VAC/1 min Insulation class: A						
Mounting direction	Can be installed in any direction.						
Protection structure	Totally enclosed self-cooled type (IP54)						

The table shows typical output values of actuators.

*1: Indicates typical characteristics when combined with MINAS A6 (driven using an ideal sine wave).

For combinations with servo amplifiers, refer to [1-3 Combinations with servo amplifier and extension cables] (P1-4).

*2: Value after temperature rise and saturation when the 320×320×16 [mm] aluminum radiation plate is installed.

*3: Value of phase induced voltage constant multiplied by 3.

*4: For testing conditions, refer to [1-12 Shock resistance] (P1-41) and [1-13 Resistance to vibration] (P1-42).

Motor operation is not guaranteed in applications where vibrations and impacts are continuously applied for a long period of time.

*5: The multi-turn detector range is -32768 to 32767.

*6: For details, refer to [3-3 Location and installation] (P3-6).

SG type

Item		Model	SHA25P				
			51	81	101	121	161
Max. torque* ¹	N·m		127	178	204	217	229
	kgf·m		13.0	18.2	20.8	22.1	23.4
Allowable continuous torque** ²	N·m		41	67	81	81	81
	kgf·m		4.2	6.8	8.2	8.2	8.2
Max. rotational speed* ¹	r/min		109.8	69.1	55.4	46.3	34.8
Torque constant* ¹	N·m/A		19	31	39	46	62
	kgf·m/A		2.0	3.2	4.0	4.7	6.3
Max. current* ¹	A		8.6	7.5	7.0	6.3	5.2
Allowable continuous current** ²	A		3.0	3.0	2.9	2.6	2.1
EMF constant* ³	V/(r/min)		2.2	3.5	4.3	5.2	6.9
Phase resistance (20 °C)	Ω		1.2				
Phase inductance	mH		3				
Inertia moment (without brake)	GD ² /4	kg·m ²	0.56	1.4	2.2	3.2	5.6
	J	kgf·cm·s ²	5.7	14	22	32	57
Inertia moment (with brake)	GD ² /4	kg·m ²	0.66	1.7	2.6	3.7	6.6
	J	kgf·cm·s ²	6.7	17	26	38	67
Reduction ratio	—		1:51	1:81	1:101	1:121	1:161
Permissible moment load	N·m		258				
	kgf·m		26.3				
Moment stiffness	N·m/rad		39.2 × 10 ⁴				
	kgf·m/arc-min		11.6				
Uni-directional positional accuracy	Sec.		50	40	40	40	40
Encoder type	—		Magnetic absolute encoder				
Encoder resolution	Single-turn detector		2 ¹⁷ (131072)				
	Multi-turn detector* ⁵		2 ¹⁶ (65536)				
Output shaft resolution	Pulse/rev		6684672	10616832	13238272	15859712	21102592
Mass (without brake)	kg		2.95				
Mass (with brake)	kg		3.1				
Environmental conditions* ⁶	Operating temperature: 0 to 40 °C/Storage temperature: -20 to 60 °C Operating humidity/storage humidity: 20 to 80 %RH (no condensation) Resistance to vibration* ⁴ :25 m/s ² (frequency:10 to 400 Hz) Shock resistance* ⁴ :300 m/s ² No dust, no metal powder, no corrosive gas, no inflammable gas, no oil mist To be used indoors, no direct sunlight Altitude: less than 1000 m above sea level						
Motor insulation	Insulation resistance: 100 MΩ or more (by 500 VDC insulation tester) Dielectric strength: 1500 VAC/1 min Insulation class: A						
Mounting direction	Can be installed in any direction.						
Protection structure	Totally enclosed self-cooled type (IP54)						

The table shows typical output values of actuators.

*1: Indicates typical characteristics when combined with MINAS A6 (driven using an ideal sine wave).

For combinations with servo amplifiers, refer to [1-3 Combinations with servo amplifier and extension cables] (P1-4).

*2: Value after temperature rise and saturation when the 350×350×18 [mm] aluminum radiation plate is installed.

*3: Value of phase induced voltage constant multiplied by 3.

*4: For testing conditions, refer to [1-12 Shock resistance] (P1-41) and [1-13 Resistance to vibration] (P1-42).

Motor operation is not guaranteed in applications where vibrations and impacts are continuously applied for a long period of time.

*5: The multi-turn detector range is -32768 to 32767.

*6: For details, refer to [3-3 Location and installation] (P3-6).

SG type

Item		Model	SHA32P				
			51	81	101	121	161
Max. torque* ¹	N·m		281	395	433	459	484
	kgf·m		28.7	40.3	44.2	46.8	49.4
Allowable continuous torque** ²	N·m		92	153	178	178	178
	kgf·m		9.4	15.6	18.2	18.2	18.2
Max. rotational speed* ¹	r/min		94.1	59.3	47.5	39.7	29.8
Torque constant* ¹	N·m/A		21	33	42	50	66
	kgf·m/A		2.1	3.4	4.2	5.1	6.8
Max. current* ¹	A		17.3	15.2	13.5	12.2	9.9
Allowable continuous current** ²	A		6.0	6.0	5.7	5.0	4.1
EMF constant* ³	V/(r/min)		2.3	3.7	4.7	5.6	7.4
Phase resistance (20 °C)	Ω		0.33				
Phase inductance	mH		1.4				
Inertia moment (without brake)	GD ² /4	kg·m ²	2.0	5.1	8.0	11	20
	J	kgf·cm·s ²	21	52	81	117	207
Inertia moment (with brake)	GD ² /4	kg·m ²	2.3	5.9	9.2	13	23
	J	kgf·cm·s ²	24	60	94	135	238
Reduction ratio	—		1:51	1:81	1:101	1:121	1:161
Permissible moment load	N·m		580				
	kgf·m		59.1				
Moment stiffness	N·m/rad		100 × 10 ⁴				
	kgf·m/arc-min		29.6				
Uni-directional positional accuracy	Sec.		50	40	40	40	40
Encoder type	—		Magnetic absolute encoder				
Encoder resolution	Single-turn detector		2 ¹⁷ (131072)				
	Multi-turn detector* ⁵		2 ¹⁶ (65536)				
Output shaft resolution	Pulse/rev		6684672	10616832	13238272	15859712	21102592
Mass (without brake)	kg		5.9				
Mass (with brake)	kg		6.2				
Environmental conditions* ⁶	Operating temperature: 0 to 40 °C/Storage temperature: -20 to 60 °C Operating humidity/storage humidity: 20 to 80 %RH (no condensation) Resistance to vibration* ⁴ :25 m/s ² (frequency:10 to 400 Hz) Shock resistance* ⁴ :300 m/s ² No dust, no metal powder, no corrosive gas, no inflammable gas, no oil mist To be used indoors, no direct sunlight Altitude: less than 1000 m above sea level						
Motor insulation	Insulation resistance: 100 MΩ or more (by 500 VDC insulation tester) Dielectric strength: 1500 VAC/1 min Insulation class: A						
Mounting direction	Can be installed in any direction.						
Protection structure	Totally enclosed self-cooled type (IP54)						

The table shows typical output values of actuators.

*1: Indicates typical characteristics when combined with MINAS A6 (driven using an ideal sine wave).

For combinations with servo amplifiers, refer to [1-3 Combinations with servo amplifier and extension cables] (P1-4).

*2: Value after temperature rise and saturation when the 400×400×20 [mm] aluminum radiation plate is installed.

*3: Value of phase induced voltage constant multiplied by 3.

*4: For testing conditions, refer to [1-12 Shock resistance] (P1-41) and [1-13 Resistance to vibration] (P1-42).

Motor operation is not guaranteed in applications where vibrations and impacts are continuously applied for a long period of time.

*5: The multi-turn detector range is -32768 to 32767.

*6: For details, refer to [3-3 Location and installation] (P3-6).

SG type

Item		Model	SHA40P				
			51	81	101	121	161
Max. torque* ¹	N·m		523	675	738	802	841
	kgf·m		53.4	68.9	75.3	81.8	85.8
Allowable continuous torque* ^{1,2}	N·m		160	263	330	382	382
	kgf·m		16.3	26.8	33.7	39	39
Max. rotational speed* ¹	r/min		78.4	49.4	39.6	33.1	24.8
Torque constant* ¹	N·m/A		25	41	51	61	81
	kgf·m/A		2.6	4.1	5.2	6.2	8.2
Max. current* ¹	A		26.7	21.8	19.4	17.9	14.6
Allowable continuous current* ^{1,2}	A		9.0	9.0	9.0	8.8	7.2
EMF constant* ³	V/(r/min)		2.9	4.6	5.7	6.8	9.1
Phase resistance (20 °C)	Ω		0.19				
Phase inductance	mH		1.2				
Inertia moment (without brake)	GD ² /4	kg·m ²	5.0	13	20	28	50
	J	kgf·cm·s ²	51	130	202	290	513
Inertia moment (with brake)	GD ² /4	kg·m ²	6.1	15	24	34	61
	J	kgf·cm·s ²	62	157	244	350	619
Reduction ratio	—		1:51	1:81	1:101	1:121	1:161
Permissible moment load	N·m		849				
	kgf·m		86.6				
Moment stiffness	N·m/rad		179 × 10 ⁴				
	kgf·m/arc-min		53.2				
Uni-directional positional accuracy	Sec.		50	40	40	40	40
Encoder type	—		Magnetic absolute encoder				
Encoder resolution	Single-turn detector		2 ¹⁷ (131072)				
	Multi-turn detector* ⁵		2 ¹⁶ (65536)				
Output shaft resolution	Pulse/rev		6684672	10616832	13238272	15859712	21102592
Mass (without brake)	kg		9.9				
Mass (with brake)	kg		10.7				
Environmental conditions* ⁶	Operating temperature: 0 to 40 °C/Storage temperature: -20 to 60 °C Operating humidity/storage humidity: 20 to 80 %RH (no condensation) Resistance to vibration* ⁴ :25 m/s ² (frequency:10 to 400 Hz) Shock resistance* ⁴ :300 m/s ² No dust, no metal powder, no corrosive gas, no inflammable gas, no oil mist To be used indoors, no direct sunlight Altitude: less than 1000 m above sea level						
Motor insulation	Insulation resistance: 100 MΩ or more (by 500 VDC insulation tester) Dielectric strength: 1500 VAC/1 min Insulation class: A						
Mounting direction	Can be installed in any direction.						
Protection structure	Totally enclosed self-cooled type (IP54)						

The table shows typical output values of actuators.

*1: Indicates typical characteristics when combined with MINAS A6 (driven using an ideal sine wave).

For combinations with servo amplifiers, refer to [1-3 Combinations with servo amplifier and extension cables] (P1-4).

*2: Value after temperature rise and saturation when the 500×500×25 [mm] aluminum radiation plate is installed.

*3: Value of phase induced voltage constant multiplied by 3.

*4: For testing conditions, refer to [1-12 Shock resistance] (P1-41) and [1-13 Resistance to vibration] (P1-42).

Motor operation is not guaranteed in applications where vibrations and impacts are continuously applied for a long period of time.

*5: The multi-turn detector range is -32768 to 32767.

*6: For details, refer to [3-3 Location and installation] (P3-6).

SG type

Item	Model	SHA45P					
		51	81	101	121	161	
Max. torque* ¹	N·m	650	918	982	1070	1147	
	kgf·m	66.3	93.6	100	109	117	
Allowable continuous torque* ^{1,2}	N·m	174	290	363	437	523	
	kgf·m	17.7	29.6	37.0	44.6	53.3	
Max. rotational speed* ¹	r/min	74.5	46.9	37.6	31.4	23.6	
Torque constant* ¹	N·m/A	25	41	51	61	81	
	kgf·m/A	2.6	4.1	5.2	6.2	8.2	
Max. current* ¹	A	36.5	29.9	25.9	24.5	19.3	
Allowable continuous current* ^{1,2}	A	10.0	10.0	10.0	10.0	9.2	
EMF constant* ³	V/(r/min)	2.9	4.6	5.7	6.8	9.1	
Phase resistance (20 °C)	Ω	0.19					
Phase inductance	mH	1.2					
Inertia moment (without brake)	GD ² /4	kg·m ²	6.8	17	27	38	68
	J	kgf·cm·s ²	69	175	272	390	690
Inertia moment (with brake)	GD ² /4	kg·m ²	7.9	20	31	45	79
	J	kgf·cm·s ²	81	204	316	454	804
Reduction ratio	—	1:51	1:81	1:101	1:121	1:161	
Permissible moment load	N·m	1127					
	kgf·m	115					
Moment stiffness	N·m/rad	257 × 10 ⁴					
	kgf·m/arc-min	76.3					
Uni-directional positional accuracy	Sec.	50	40	40	40	40	
Encoder type	—	Absolute encoder					
Encoder resolution	Single-turn detector	2 ¹⁷ (131072)					
	Multi-turn detector* ⁵	2 ¹⁶ (65536)					
Output shaft resolution	Pulse/rev	6684672	10616832	13238272	15859712	21102592	
Mass (without brake)	kg	12.4					
Mass (with brake)	kg	13.2					
Environmental conditions* ⁶	Operating temperature: 0 to 40 °C/Storage temperature: -20 to 60 °C Operating humidity/storage humidity: 20 to 80 %RH (no condensation) Resistance to vibration* ⁴ :25 m/s ² (frequency:10 to 400 Hz) Shock resistance* ⁴ :300 m/s ² No dust, no metal powder, no corrosive gas, no inflammable gas, no oil mist To be used indoors, no direct sunlight Altitude: less than 1000 m above sea level						
Motor insulation	Insulation resistance: 100 MΩ or more (by 500 VDC insulation tester) Dielectric strength: 1500 VAC /1 min Insulation class: A						
Mounting direction	Can be installed in any direction.						
Protection structure	Totally enclosed self-cooled type (IP54)						

The table shows typical output values of actuators.

*1: Indicates typical characteristics when combined with MINAS A6 (driven using an ideal sine wave).

For combinations with servo amplifiers, refer to [1-3 Combinations with servo amplifier and extension cables] (P1-4).

*2: Value after temperature rise and saturation when the 500×500×25 [mm] aluminum radiation plate is installed.

*3: Value of phase induced voltage constant multiplied by 3.

*4: For testing conditions, refer to [1-12 Shock resistance] (P1-41) and [1-13 Resistance to vibration] (P1-42).

Motor operation is not guaranteed in applications where vibrations and impacts are continuously applied for a long period of time.

*5: The multi-turn detector range is -32768 to 32767.

*6: For details, refer to [3-3 Location and installation] (P3-6).

SG type

Item		Model	SHA58P				SHA65P			
			81	101	121	161	81	101	121	161
Max. torque* ¹	N·m		1924	2067	2236	2392	2743	2990	3263	3419
	kgf·m		196	211	228	244	280	305	333	349
Allowable continuous torque* ^{1,2}	N·m		714	905	969	969	921	1149	1236	1236
	kgf·m		73	92	99	99	94	117	126	126
Max. rotational speed* ¹	r/min		37.0	29.7	24.8	18.6	34.6	27.7	23.1	17.4
Torque constant* ¹	N·m/A		54	68	81	108	54	68	81	108
	kgf·m/A		5.5	6.9	8.3	11.0	5.5	6.9	8.3	11.0
Max. current* ¹	A		45	39	36	30	62	55	51	41
Allowable continuous current* ^{1,2}	A		17.7	17.8	16.4	13.4	22.0	21.9	20.1	16.3
EMF constant* ³	V/(r/min)		6.1	7.6	9.1	12.1	6.1	7.6	9.1	12.1
Phase resistance (20 °C)	Ω		0.028				0.028			
Phase inductance	mH		0.29				0.29			
Inertia moment (without brake)	GD ² /4	kg·m ²	96	149	214	379	110	171	245	433
	J	kgf·cm·s ²	980	1520	2180	3870	1120	1740	2500	4420
Inertia moment (with brake)	GD ² /4	kg·m ²	106	165	237	420	120	187	268	475
	J	kgf·cm·s ²	1090	1690	2420	4290	1230	1910	2740	4850
Reduction ratio	—		1:81	1:101	1:121	1:161	1:81	1:101	1:121	1:161
Permissible moment load	N·m		2180				2740			
	kgf·m		222				280			
Moment stiffness	N·m/rad		531 × 10 ⁴				741 × 10 ⁴			
	kgf·m/arc-min		158				220			
Uni-directional positional accuracy	Sec.		40	40	40	40	40	40	40	40
Encoder type	—		Magnetic absolute encoder							
Encoder resolution	Single-turn detector		2 ¹⁷ (131072)							
	Multi-turn detector* ⁵		2 ¹⁶ (65536)							
Output shaft resolution	Pulse/rev		10616832	13238272	15859712	21102592	10616832	13238272	15859712	21102592
Mass (without brake)	kg		29.5				37.5			
Mass (with brake)	kg		32				40			
Environmental conditions* ⁶	Operating temperature: 0 to 40 °C/Storage temperature: -20 to 60 °C Operating humidity/storage humidity: 20 to 80 %RH (no condensation) Resistance to vibration* ⁴ : 25 m/s ² (frequency: 10 to 400 Hz) Shock resistance* ⁴ : 300 m/s ² No dust, no metal powder, no corrosive gas, no inflammable gas, no oil mist To be used indoors, no direct sunlight Altitude: less than 1000 m above sea level									
Motor insulation	Insulation resistance: 100 MΩ or more (by 500 VDC insulation tester) Dielectric strength: 1500 VAC/1 min Insulation class: A									
Mounting direction	Can be installed in any direction.									
Protection structure	Totally enclosed self-cooled type (IP54)									

The table shows typical output values of actuators.

*1: Indicates typical characteristics when combined with MINAS A6 (driven using an ideal sine wave).

For combinations with servo amplifiers, refer to [1-3 Combinations with servo amplifier and extension cables] (P1-4).

*2: Value after temperature rise and saturation when the 650×650×30 [mm] aluminum radiation plate is installed.

*3: Value of phase induced voltage constant multiplied by 3.

*4: For testing conditions, refer to [1-12 Shock resistance] (P1-41) and [1-13 Resistance to vibration] (P1-42).

Motor operation is not guaranteed in applications where vibrations and impacts are continuously applied for a long period of time.

*5: The multi-turn detector range is -32768 to 32767.

*6: For details, refer to [3-3 Location and installation] (P3-6).

CG type

Item		Model	SHA20P				
			50	80	100	120	160
Max. torque* ¹	N·m		73	96	107	113	120
	kgf·m		7.4	9.8	10.9	11.5	12.2
Allowable continuous torque* ^{1,2}	N·m		21	35	43	48	48
	kgf·m		2.1	3.6	4.4	4.9	4.9
Max. rotational speed* ¹	r/min		120	75	60	50	37.5
Torque constant* ¹	N·m/A		16	26	33	39	53
	kgf·m/A		1.7	2.7	3.4	4.0	5.4
Max. current* ¹	A		6.1	5.0	4.6	4.1	3.4
Allowable continuous current* ^{1,2}	A		2.1	2.1	2.1	2.0	1.7
EMF constant* ³	V/(r/min)		1.8	2.9	3.7	4.4	5.9
Phase resistance (20 °C)	Ω		1.4				
Phase inductance	mH		2.5				
Inertia moment (without brake)	GD ² /4	kg·m ²	0.21	0.53	0.82	1.2	2.1
	J	kgf·cm·s ²	2.1	5.4	8.0	12	22
Inertia moment (with brake)	GD ² /4	kg·m ²	0.23	0.60	0.94	1.3	2.4
	J	kgf·cm·s ²	2.4	6.1	9.6	14	24
Reduction ratio	—		1:50	1:80	1:100	1:120	1:160
Permissible moment load	N·m		187				
	kgf·m		19.1				
Moment stiffness	N·m/rad		25.2 × 10 ⁴				
	kgf·m/arc-min		7.5				
Uni-directional positional accuracy	Sec.		60	50	50	50	50
Repeatability	Sec.		±5				
Reverse positional accuracy	Sec.		75	30	30	30	30
Encoder type	—		Absolute encoder				
Encoder resolution	Single-turn detector		2 ¹⁷ (131072)				
	Multi-turn detector* ⁵		2 ¹⁶ (65536)				
Output shaft resolution	Pulse/rev		6553600	10485760	13107200	15728640	20971520
Mass (without brake)	kg		2.6				
Mass (with brake)	kg		2.7				
Environmental conditions* ⁶	Operating temperature: 0 to 40 °C/Storage temperature: -20 to 60 °C Operating humidity/storage humidity: 20 to 80 %RH (no condensation) Resistance to vibration* ⁴ : 25 m/s ² (frequency: 10 to 400 Hz) Shock resistance* ⁴ : 300 m/s ² No dust, no metal powder, no corrosive gas, no inflammable gas, no oil mist To be used indoors, no direct sunlight Altitude: less than 1000 m above sea level						
Motor insulation	Insulation resistance: 100 MΩ or more (by 500 VDC insulation tester) Dielectric strength: 1500 VAC/1 min Insulation class: A						
Mounting direction	Can be installed in any direction						
Protection structure	Totally enclosed self-cooled type (IP54)						

The table shows typical output values of actuators.

*1: Indicates typical characteristics when combined with MINAS A6 (driven using an ideal sine wave).

For combinations with servo amplifiers, refer to [1-3 Combinations with servo amplifier and extension cables] (P1-4).

*2: Value after temperature rise and saturation when the 320×320×16 [mm] aluminum radiation plate is installed.

*3: Value of phase induced voltage constant multiplied by 3.

*4: For testing conditions, refer to [1-12 Shock resistance] (P1-41) and [1-13 Resistance to vibration] (P1-42).

Motor operation is not guaranteed in applications where vibrations and impacts are continuously applied for a long period of time.

*5: The multi-turn detector range is -32768 to 32767.

*6: For details, refer to [3-3 Location and installation] (P3-6).

CG type

Item		Model	SHA25P				
			50	80	100	120	160
Max. torque* ¹	N·m		127	178	204	217	229
	kgf·m		13.0	18.2	20.8	22.1	23.4
Allowable continuous torque* ^{1,2}	N·m		40	66	81	81	81
	kgf·m		4.1	6.8	8.2	8.2	8.2
Max. rotational speed* ¹	r/min		112	70	56	46.7	35
Torque constant* ¹	N·m/A		19	31	38	46	61
	kgf·m/A		1.9	3.1	3.9	4.7	6.3
Max. current* ¹	A		8.7	7.6	7.0	6.3	5.2
Allowable continuous current* ^{1,2}	A		3.0	3.0	3.0	2.6	2.1
EMF constant* ³	V/(r/min)		2.1	3.4	4.3	5.2	6.9
Phase resistance (20 °C)	Ω		1.2				
Phase inductance	mH		3.0				
Inertia moment (without brake)	GD ² /4	kg·m ²	0.50	1.3	2.0	2.9	5.1
	J	kgf·cm·s ²	5.1	13	20	29	52
Inertia moment (with brake)	GD ² /4	kg·m ²	0.60	1.5	2.4	3.4	6.1
	J	kgf·cm·s ²	6.1	16	24	35	62
Reduction ratio	—		1:50	1:80	1:100	1:120	1:160
Permissible moment load	N·m		258				
	kgf·m		26.3				
Moment stiffness	N·m/rad		39.2 × 10 ⁴				
	kgf·m/arc-min		11.6				
Uni-directional positional accuracy	Sec.		50	40	40	40	40
Repeatability	Sec.		±5				
Reverse positional accuracy	Sec.		60	25	25	25	25
Encoder type	—		Magnetic absolute encoder				
Encoder resolution	Single-turn detector		2 ¹⁷ (131072)				
	Multi-turn detector* ⁵		2 ¹⁶ (65536)				
Output shaft resolution	Pulse/rev		6553600	10485760	13107200	15728640	20971520
Mass (without brake)	kg		3.95				
Mass (with brake)	kg		4.1				
Environmental conditions* ⁶	Operating temperature: 0 to 40 °C/Storage temperature: -20 to 60 °C Operating humidity/storage humidity: 20 to 80 %RH (no condensation) Resistance to vibration* ⁴ : 25 m/s ² (frequency: 10 to 400 Hz) Shock resistance* ⁴ : 300 m/s ² No dust, no metal powder, no corrosive gas, no inflammable gas, no oil mist To be used indoors, no direct sunlight Altitude: less than 1000 m above sea level						
Motor insulation	Insulation resistance: 100 MΩ or more (by 500 VDC insulation tester) Dielectric strength: 1500 VAC/1 min Insulation class: A						
Mounting direction	Can be installed in any direction.						
Protection structure	Totally enclosed self-cooled type (IP54)						

The table shows typical output values of actuators.

*1: Indicates typical characteristics when combined with MINAS A6 (driven using an ideal sine wave).

For combinations with servo amplifiers, refer to [1-3 Combinations with servo amplifier and extension cables] (P1-4).

*2: Value after temperature rise and saturation when the 350×350×18 [mm] aluminum radiation plate is installed.

*3: Value of phase induced voltage constant multiplied by 3.

*4: For testing conditions, refer to [1-12 Shock resistance] (P1-41) and [1-13 Resistance to vibration] (P1-42).

Motor operation is not guaranteed in applications where vibrations and impacts are continuously applied for a long period of time.

*5: The multi-turn detector range is -32768 to 32767.

*6: For details, refer to [3-3 Location and installation] (P3-6).

CG type

Item		Model	SHA32P				
			50	80	100	120	160
Max. torque* ¹	N·m		281	395	433	459	484
	kgf·m		28.7	40.3	44.2	46.8	49.4
Allowable continuous torque* ^{1,2}	N·m		90	151	178	178	178
	kgf·m		9.2	15.4	18.2	18.2	18.2
Max. rotational speed* ¹	r/min		96	60	48	40	30
Torque constant* ¹	N·m/A		20	33	41	49	66
	kgf·m/A		2.1	3.4	4.2	5.0	6.7
Max. current* ¹	A		17.7	15.4	13.7	12.2	10.0
Allowable continuous current* ^{1,2}	A		6.0	6.0	5.7	5.0	4.1
EMF constant* ³	V/(r/min)		2.3	3.7	4.6	5.5	7.4
Phase resistance (20 °C)	Ω		0.33				
Phase inductance	mH		1.4				
Inertia moment (without brake)	GD ² /4	kg·m ²	1.7	4.3	6.7	9.7	17
	J	kgf·cm·s ²	17	44	68	99	175
Inertia moment (with brake)	GD ² /4	kg·m ²	2.0	5.1	7.9	11	20
	J	kgf·cm·s ²	20	52	81	116	207
Reduction ratio	—		1:50	1:80	1:100	1:120	1:160
Permissible moment load	N·m		580				
	kgf·m		59.2				
Moment stiffness	N·m/rad		100 × 10 ⁴				
	kgf·m/arc-min		29.6				
Uni-directional positional accuracy	Sec.		40	30	30	30	30
Repeatability	Sec.		±4				
Reverse positional accuracy	Sec.		60	25	25	25	25
Encoder type	—		Magnetic absolute encoder				
Encoder resolution	Single-turn detector		2 ¹⁷ (131072)				
	Multi-turn detector* ⁵		2 ¹⁶ (65536)				
Output shaft resolution	Pulse/rev		6553600	10485760	13107200	15728640	20971520
Mass (without brake)	kg		7.7				
Mass (with brake)	kg		8.0				
Environmental conditions* ⁶	Operating temperature: 0 to 40 °C/Storage temperature: -20 to 60 °C Operating humidity/storage humidity: 20 to 80 %RH (no condensation) Resistance to vibration* ⁴ : 25 m/s ² (frequency: 10 to 400 Hz) Shock resistance* ⁴ : 300 m/s ² No dust, no metal powder, no corrosive gas, no inflammable gas, no oil mist To be used indoors, no direct sunlight Altitude: less than 1000 m above sea level						
Motor insulation	Insulation resistance: 100 MΩ or more (by 500 VDC insulation tester) Dielectric strength: 1500 VAC/1 min Insulation class: A						
Mounting direction	Can be installed in any direction.						
Protection structure	Totally enclosed self-cooled type (IP54)						

The table shows typical output values of actuators.

*1: Indicates typical characteristics when combined with MINAS A6 (driven using an ideal sine wave).

For combinations with servo amplifiers, refer to [1-3 Combinations with servo amplifier and extension cables] (P1-4).

*2: Value after temperature rise and saturation when the 400×400×20 [mm] aluminum radiation plate is installed.

*3: Value of phase induced voltage constant multiplied by 3.

*4: For testing conditions, refer to [1-12 Shock resistance] (P1-41) and [1-13 Resistance to vibration] (P1-42).

Motor operation is not guaranteed in applications where vibrations and impacts are continuously applied for a long period of time.

*5: The multi-turn detector range is -32768 to 32767.

*6: For details, refer to [3-3 Location and installation] (P3-6).

CG type

Item		Model	SHA40P				
			50	80	100	120	160
Max. torque ^{*1}	N·m		523	675	738	802	841
	kgf·m		53.4	68.9	75.3	81.8	85.8
Allowable continuous torque ^{*1,2}	N·m		157	260	327	382	382
	kgf·m		16.0	26.5	33.3	39.0	39.0
Max. rotational speed ⁺	r/min		80	50	40	33.3	25
Torque constant ^{*1}	N·m/A		25	40	50	60	80
	kgf·m/A		2.5	4.1	5.1	6.1	8.2
Max. current ^{*1}	A		27.2	22.0	19.6	18.0	14.7
Allowable continuous current ^{*1,2}	A		9.0	9.0	9.0	8.8	7.2
EMF constant ^{*3}	V/(r/min)		2.8	4.5	5.6	6.7	9.0
Phase resistance (20 °C)	Ω		0.19				
Phase inductance	mH		1.2				
Inertia moment (without brake)	GD ² /4	kg·m ²	4.8	12	19	27	49
	J	kgf·cm·s ²	49	124	194	280	497
Inertia moment (with brake)	GD ² /4	kg·m ²	5.8	15	23	33	59
	J	kgf·cm·s ²	59	150	235	338	601
Reduction ratio	—		1:50	1:80	1:100	1:120	1:160
Permissible moment load	N·m		849				
	kgf·m		86.6				
Moment stiffness	N·m/rad		179 × 10 ⁴				
	kgf·m/arc-min		53.2				
Uni-directional positional accuracy	Sec.		40	30	30	30	30
Repeatability	Sec.		±4				
Reverse positional accuracy	Sec.		50	20	20	20	20
Encoder type	—		Magnetic absolute encoder				
Encoder resolution	Single-turn detector		2 ¹⁷ (131072)				
	Multi-turn detector ^{*5}		2 ¹⁶ (65536)				
Output shaft resolution	Pulse/rev		6553600	10485760	13107200	15728640	20971520
Mass (without brake)	kg		13.0				
Mass (with brake)	kg		13.8				
Environmental conditions ^{*6}	Operating temperature: 0 to 40 °C/Storage temperature: -20 to 60 °C Operating humidity/storage humidity: 20 to 80 %RH (no condensation) Resistance to vibration ^{*4} : 25 m/s ² (frequency: 10 to 400 Hz) Shock resistance ^{*4} : 300 m/s ² No dust, no metal powder, no corrosive gas, no inflammable gas, no oil mist To be used indoors, no direct sunlight Altitude: less than 1000 m above sea level						
Motor insulation	Insulation resistance: 100 MΩ or more (by 500 VDC insulation tester) Dielectric strength: 1500 VAC/1 min Insulation class: A						
Mounting direction	Can be installed in any direction.						
Protection structure	Totally enclosed self-cooled type (IP54)						

The table showstypical output values of actuators.

*1: Indicates typical characteristics when combined with MINAS A6 (driven using an ideal sine wave).

For combinations with servo amplifiers, refer to [1-3 Combinations with servo amplifier and extension cables] (P1-4).

*2: Value after temperature rise and saturation when the 500×500×25 [mm] aluminum radiation plate is installed.

*3: Value of phase induced voltage constant multiplied by 3.

*4: For testing conditions, refer to [1-12 Shock resistance] (P1-41) and [1-13 Resistance to vibration] (P1-42).

Motor operation is not guaranteed in applications where vibrations and impacts are continuously applied for a long period of time.

*5: The multi-turn detector range is -32768 to 32767.

*6: For details, refer to [3-3 Location and installation] (P3-6).

1-5 Motor shaft holding brake

1

Outlines

The brakes equipped on SHA-P series actuators are used to hold the motor shaft in place when the power is cut off. With small models (SHA25P, 32P), the actuator's built-in circuit controls the voltage supplied to the brake in order to reduce the power consumption while the brake is actuated.

Be sure to use a DC power supply having proper brake excitation voltage and capable of outputting enough current consumption during suction.

Specifications

SG type

Item		Model	SHA20P					SHA25P					SHA32P				
			51	81	101	121	161	51	81	101	121	161	51	81	101	121	161
Type			Dry non-excitation actuation type (without power-saving control)					Dry non-excitation actuation type (with power-saving control)									
Brake excitation voltage	V		24 VDC \pm 10 % (no polarity) ^{*1}														
Current consumption during suction (at 20 °C)	A		0.37					0.8 ^{*2}									
Current consumption during holding (at 20 °C)	A		Same as current consumption during suction					0.3									
Holding torque ^{*3}	N·m		31	49	61	73	97	51	81	101	121	161	102	162	202	242	322
	kgf·m		3.1	5.0	6.2	7.4	9.9	5.2	8.3	10	12	16	10	17	21	25	33
Inertia moment ^{*3} (Actuator total) (With brake)	kg·m ² (GD ² /4)		0.26	0.65	1.0	1.4	2.6	0.66	1.7	2.6	3.7	6.6	2.3	5.9	9.2	13	23
	kgf·cm·s ² (J)		2.7	6.6	10	15	26	6.7	17	26	38	67	24	60	94	135	238
Mass (with brake) ^{*4}	kg		2.1					3.1					6.2				
Allowable number of normal brakings ^{*5}			100000 times														
Allowable number of emergency stops ^{*6}			200 times														

Item		Model	SHA40P					SHA45P					SHA58P				SHA65P			
			51	81	101	121	161	51	81	101	121	161	81	101	121	161	81	101	121	161
Type			Dry non-excitation actuation type (without power-saving control)																	
Brake excitation voltage	V		24 VDC \pm 10 % (no polarity) ^{*1}																	
Current consumption during suction (at 20 °C)	A		0.7									0.9								
Current consumption during holding (at 20 °C)	A		Same as current consumption during suction																	
Holding torque ^{*3}	N·m		204	324	404	484	644	204	324	404	484	644	1220	1520	1820	2420	1220	1520	1820	2420
	kgf·m		21	33	41	49	66	21	33	41	49	66	124	155	185	246	124	155	185	246
Inertia moment ^{*3} (Actuator total) (With brake)	kg·m ² (GD ² /4)		6.1	15	24	34	61	7.9	20	31	45	79	106	165	237	420	120	187	268	475
	kgf·cm·s ² (J)		62	157	244	350	619	81	204	316	454	804	1090	1690	2420	4290	1230	1910	2740	4850
Mass (with brake) ^{*4}	kg		10.7					13.2					32				40			
Allowable number of normal brakings ^{*5}			100000 times																	
Allowable number of emergency stops ^{*6}			200 times																	

CG type

Item		Model	SHA20P					SHA25P					SHA32P				
			50	80	100	120	160	50	80	100	120	160	50	80	100	120	160
Type			Dry non-excitation actuation type (without power-saving control)					Dry non-excitation actuation type (with power-saving control)									
Brake excitation voltage	V		24 VDC \pm 10 % (no polarity) ^{*1}														
Current consumption during suction (at 20 °C)	A		0.37					0.8 ^{*2}									
Current consumption during holding (at 20 °C)	A		Same as current consumption during suction					0.3									
Holding torque ^{*3}	N·m		30	48	60	72	96	50	80	100	120	160	100	160	200	240	320
	kgf·m		3.1	4.9	6.1	7.3	9.8	5.1	8.2	10	12	16	10	16	20	24	33
Inertia moment ^{*3} (Actuator total) (With brake)	kg·m ² (GD ² /4)		0.23	0.6	0.94	1.3	2.4	0.60	1.5	2.4	3.4	6.1	2.0	5.1	7.9	11	20
	kgf·cm·s ² (J)		2.4	6.1	9.6	14	24	6.1	16	24	35	62	20	52	81	116	207
Mass (with brake) ^{*4}	kg		2.7					4.1					8.0				
Allowable number of normal brakings ^{*5}			100000 times														
Allowable number of emergency stops ^{*6}			200 times														

Item		Model	SHA40P				
			50	80	100	120	160
Type			Dry non-excitation actuation type (without power-saving control)				
Brake excitation voltage	V		24 VDC \pm 10 % (no polarity) ^{*1}				
Current consumption during suction (at 20 °C)	A		0.7				
Current consumption during holding (at 20 °C)	A		Same as current consumption during suction				
Holding torque ^{*3}	N·m		200	320	400	480	640
	kgf·m		20	33	41	49	65
Inertia moment ^{*3} (Actuator total) (With brake)	kg·m ² (GD ² /4)		5.8	15	23	33	59
	kgf·cm·s ² (J)		59	150	235	338	601
Mass (with brake) ^{*4}	kg		13.8				
Allowable number of normal brakings ^{*5}			100000 times				
Allowable number of emergency stops ^{*6}			200 times				

*1: Power supply is user's responsibility. Use a power supply capable of outputting enough current consumption during suction for the brake.

*2: The duration for current consumption during suction is 0.5 second or less for the power supply of 24 VDC \pm 10 %.

*3: The values are converted for the output shaft of the actuator.

*4: The values present total mass of the actuator.

*5: The service time for normal holding is assured when the brake activates at motor shaft rotation speed of 150 r/min or less.

*6: The service time for emergency stop is assured when the brake activates at motor speed of 3000 r/min or less provided the load inertia moment is 3 times or less than that of the actuator.

*7: Motor with holding brake may generate mechanical noise from the brake rotating body during acceleration/stopping/low speed driving, but it does not affect the performance or functionality.



The motor shaft holding brake cannot be used for deceleration.

Do not use the holding brake more than the allowable number of normal brakings (100000 times at the motor shaft rotation speed of 150 r/min or less) or allowable number of emergency stops (200 times at the motor shaft rotation speed of 3000 r/min, provided the load inertia moment is 3 times or less than that of the actuator).

Exceeding the allowable number of normal brakings and allowable number of emergency stops may deteriorate holding torque, and may consequently become out of use as a brake.

● SHA32P-CG (Speed reducer: HarmonicDrive® speed reducer CSG series for precision control)

Unit [mm] (third angle projection)

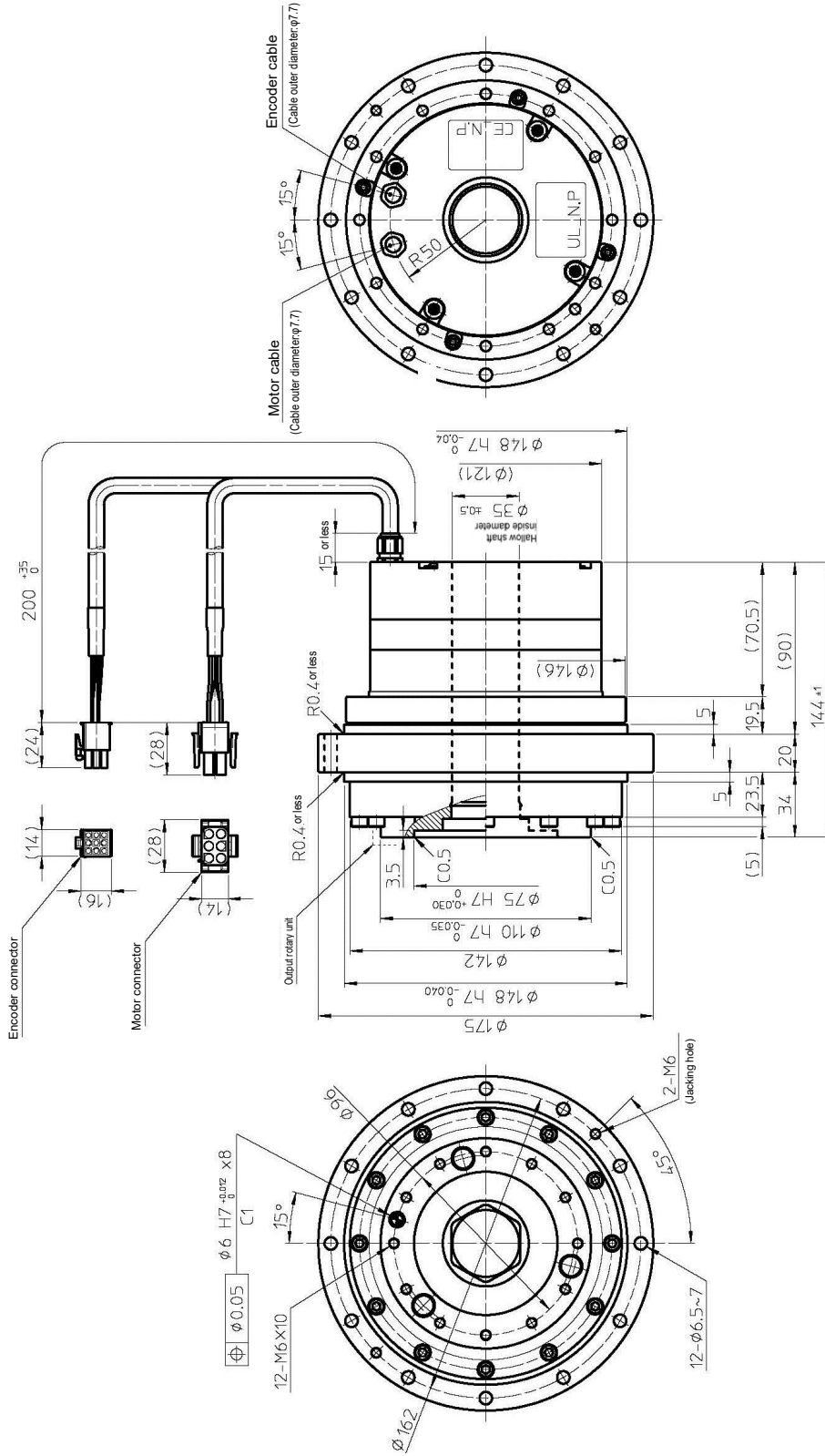

Note: For details on external dimensions, check our illustrated specifications.
Tolerances may vary due to product manufacturing method (foundry piece, machine-finished good).
Please contact us for the tolerance when it is not indicated in the dimensions.

- SHA40P-SG (Speed reducer: HarmonicDrive® speed reducer SHG series for precision control)

Unit [mm] (third angle projection)

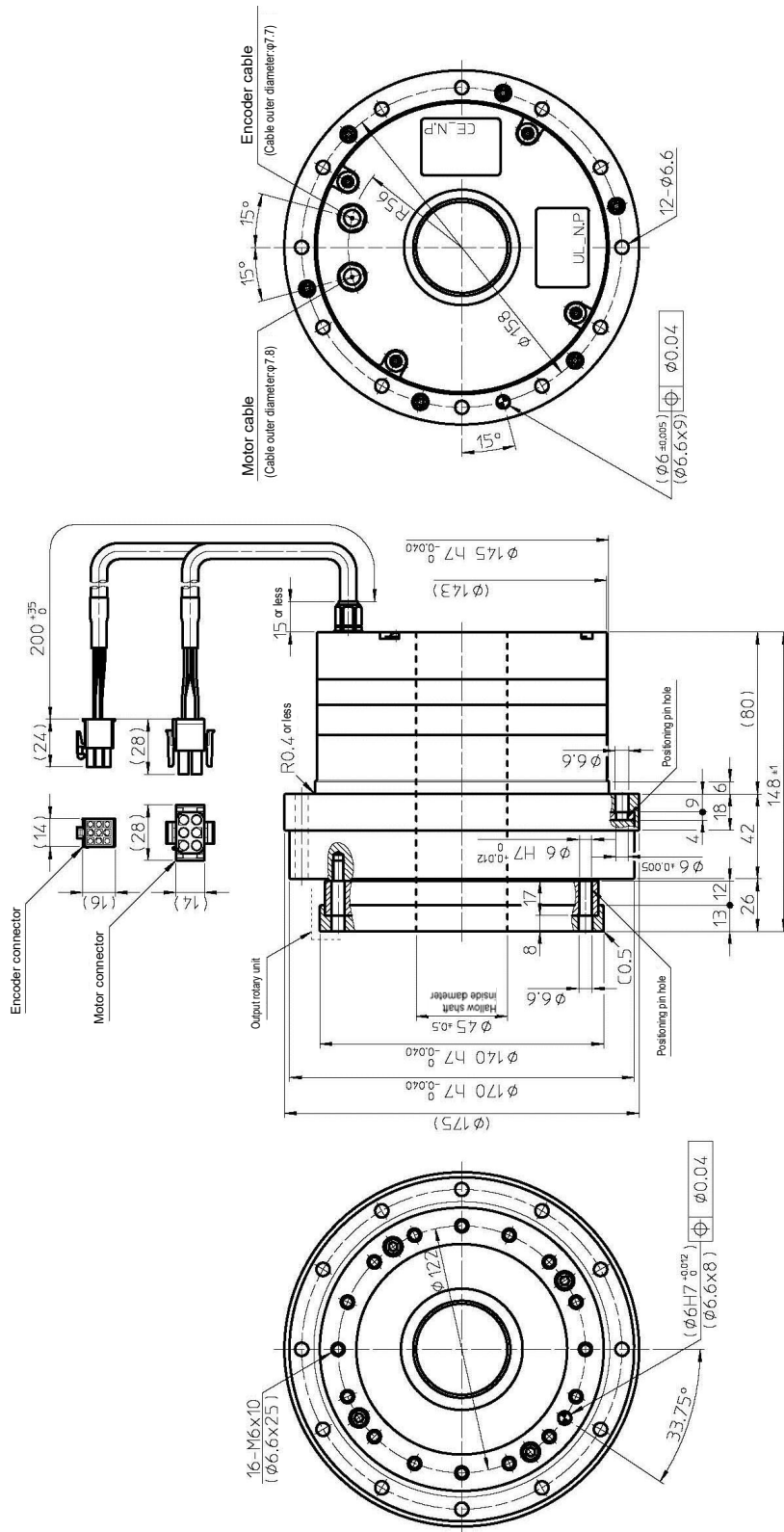

Note: For details on external dimensions, check our illustrated specifications.
Tolerances may vary due to product manufacturing method (foundry piece, machine-finished good).
Please contact us for the tolerance when it is not indicated in the dimensions.

- SHA45P-SG (Speed reducer: HarmonicDrive® speed reducer SHG series for precision control)

Unit [mm] (third angle projection)

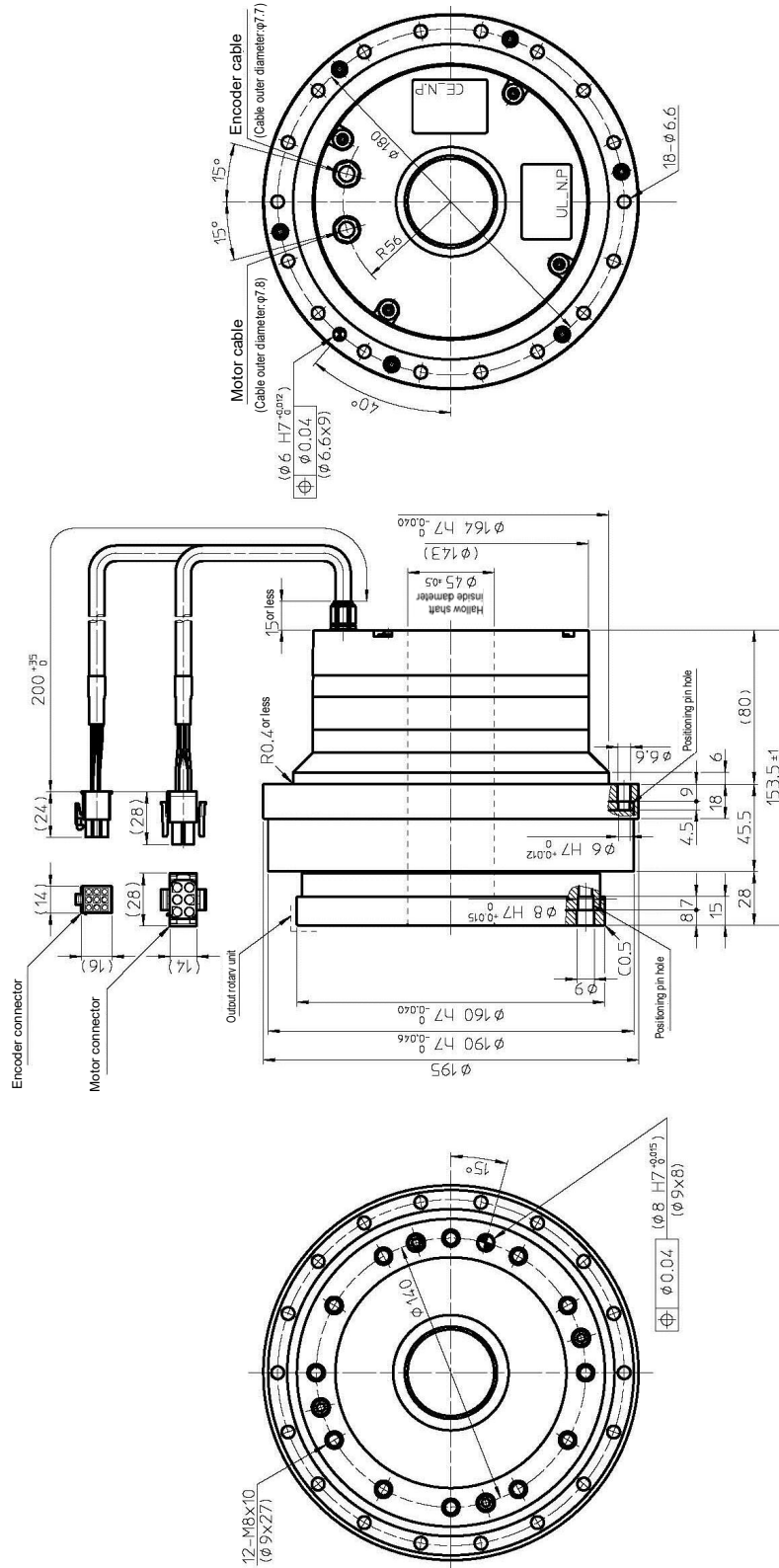

Note: For details on external dimensions, check our illustrated specifications.
Tolerances may vary due to product manufacturing method (foundry piece, machine-finished good).
Please contact us for the tolerance when it is not indicated in the dimensions.

● SHA58P-SG (Speed reducer: HarmonicDrive® speed reducer SHG series for precision control)

Unit [mm] (third angle projection)

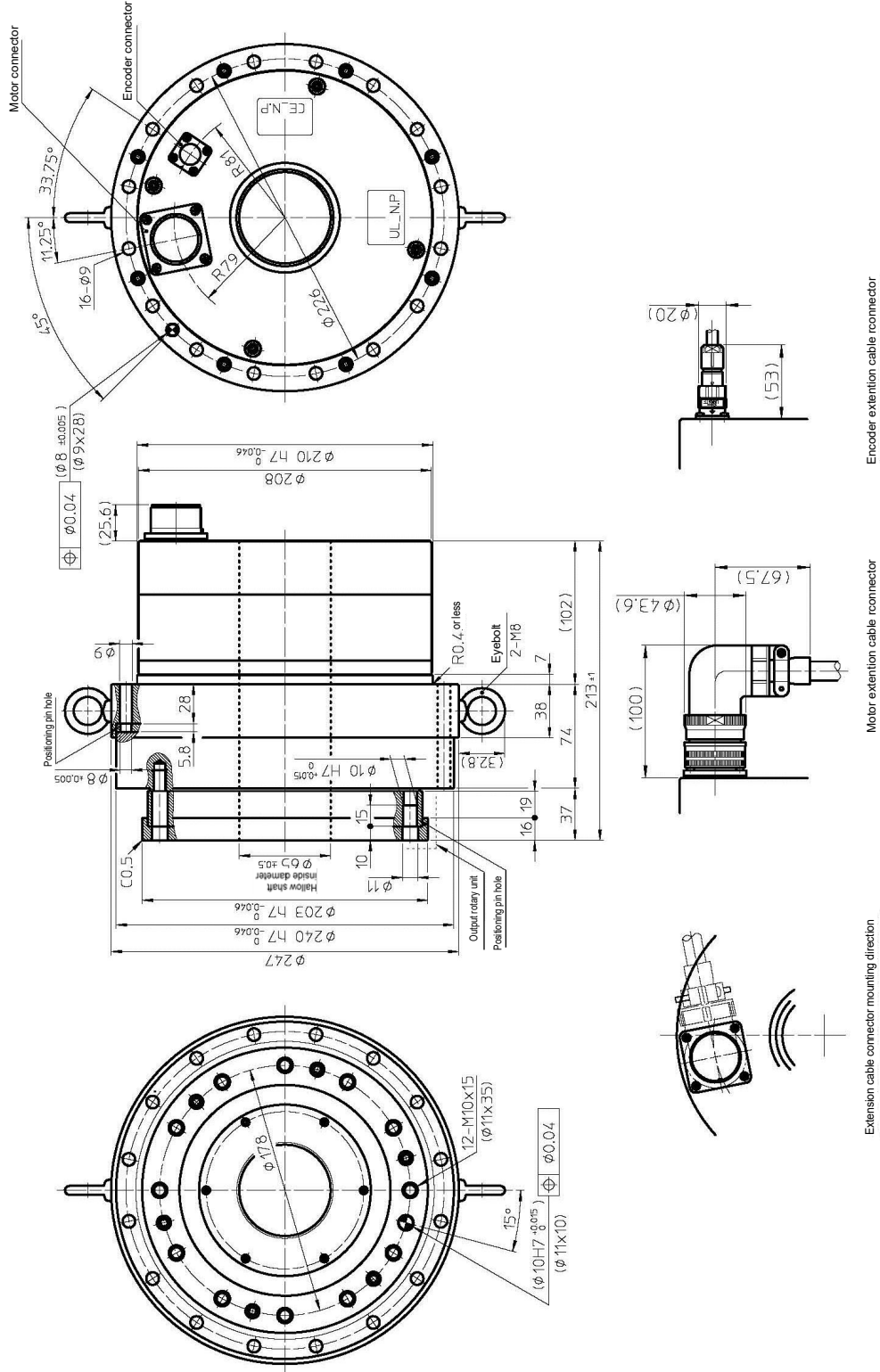

Note: For details on external dimensions, check our illustrated specifications.
 Tolerances may vary due to product manufacturing method (foundry piece, machine-finished good).
 Please contact us for the tolerance when it is not indicated in the dimensions.

- SHA65P-SG (Speed reducer: HarmonicDrive® speed reducer SHG series for precision control)

Unit [mm] (third angle projection)

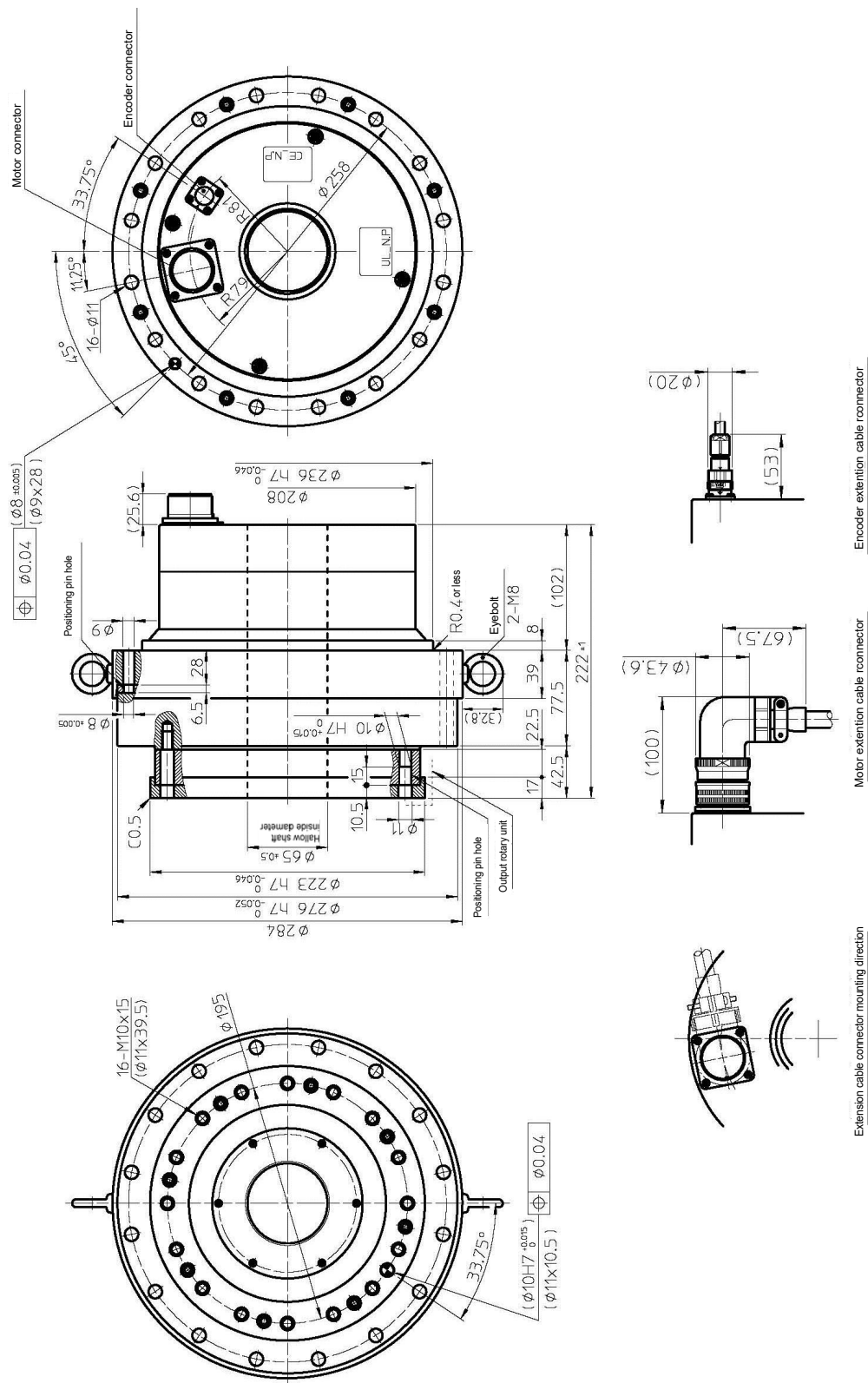

Note: For details on external dimensions, check our illustrated specifications.
 Tolerances may vary due to product manufacturing method (foundry piece, machine-finished good).
 Please contact us for the tolerance when it is not indicated in the dimensions.

1-7 Mechanical accuracy

The mechanical accuracies of the output shaft and mounting flange are shown below for SHA-P series actuators:

SG type

Unit [mm]

Accuracy items	SHA20P	SHA25P	SHA32P	SHA40P
1. Output shaft surface runout	0.030	0.035 (0.020)	0.040 (0.020)	0.045
2. Deflection of output shaft	0.030	0.035	0.040	0.045
3. Parallelism between the output shaft end mounted surface	0.030	0.035	0.040	0.045
4. Parallelism between the output shaft end mounted surface	0.055	0.050	0.055	0.060
5. Concentricity between the output shaft and fitting part	0.030	0.035	0.040	0.045
6. Concentricity between the output shaft and fitting part	0.045	0.060	0.065	0.070

Accuracy items	SHA45P	SHA58P	SHA65P
1. Output shaft surface runout	0.045	0.050	0.050
2. Deflection of output shaft	0.045	0.050	0.050
3. Parallelism between the output shaft end mounted surface	0.045	0.050	0.050
4. Parallelism between the output shaft end mounted surface	0.060	0.070	0.070
5. Concentricity between the output shaft and fitting part	0.045	0.050	0.050
6. Concentricity between the output shaft and fitting part	0.070	0.080	0.080

Note: All values are T.I.R. (Total Indicator Reading).

CG type

Unit [mm]

Accuracy items	SHA20P	SHA25P	SHA32P	SHA40P
1. Output shaft surface runout	0.010	0.010	0.010	0.010
2-1. Deflection of output shaft (Outer faucet joint)	0.010	0.010	0.010	0.010
2-2. Deflection of output shaft (Inner faucet joint)	0.015	0.015	0.015	0.015
3. Parallelism between the output shaft end mounted surface	0.030	0.030	0.035	0.035
4. Parallelism between the output shaft and fitting part	0.040	0.040	0.045	0.045
5. Concentricity between the output shaft and fitting part	0.050	0.050	0.055	0.060
6. Concentricity between the output shaft and fitting part	0.060	0.060	0.065	0.070

Note: All values are T.I.R. (Total Indicator Reading).

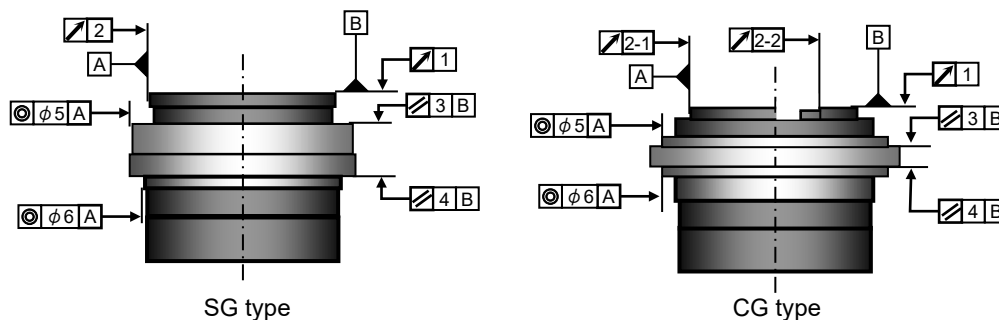

The measuring for the values are as follows:

1 Output shaft surface runout

The indicator on the fixed part measures the axial runout (maximum runout width) of the outermost circumference of output shaft of the output rotary unit per revolution.

2 Deflection of output shaft

The indicator on the fixed part measures the radial runout (maximum runout width) of output shaft of the output rotary unit per revolution.

3,4 Parallelism between the output shaft and mounted surface

The indicator on the output rotary unit measures the axial runout (maximum runout width) of the outermost circumference of the mounting surface (both on the output shaft side and opposite side) of the output rotary unit per revolution.

5,6 Concentricity between the output shaft and fitting part

The indicator on the output rotary unit measures the radial runout (maximum runout width) of the fitting part (both on the output shaft side and opposite side) of the output rotary unit per revolution.

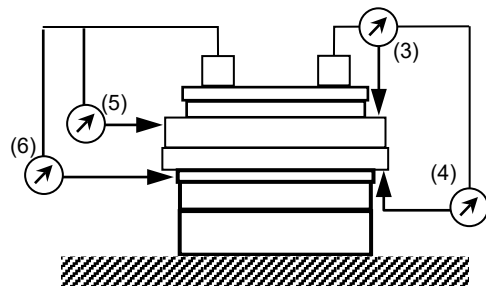
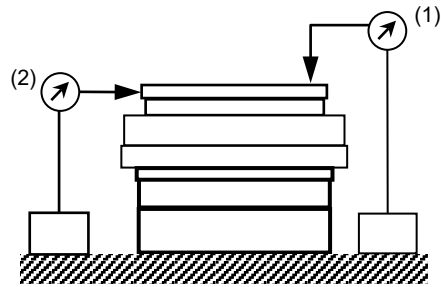

1-8 Positional accuracy

1

Outlines

Uni-directional positional accuracy

The uni-directional positional accuracy means the maximum positional difference between the actual rotated angle from the datum position and its theoretical rotational angle in one revolution when series of positioning are performed in the same rotation direction. (Refer to JIS B-6201-1987.)

Since the SHA-P series incorporates a speed reducer HarmonicDrive® for precision control, the impact of motor shaft positioning error becomes 1/multiple of reduction ratio.

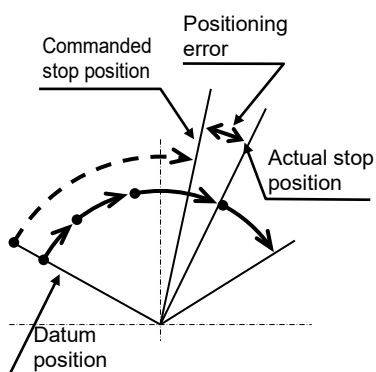

The uni-directional positional accuracy is shown in the table below:

SG type

Unit [Second]

Reduction ratio \ Model	SHA20P	SHA25P	SHA32P	SHA40P	SHA45P	SHA58P	SHA65P
1:51	60	50	50	50	50	—	—
1:81 or more	50	40	40	40	40	40	40

CG type

Unit [Second]

Reduction ratio \ Model	SHA20P	SHA25P	SHA32P	SHA40P
1:50	60	50	40	40
1:80 or more	50	40	30	30

Repeatability (CG type)

For the "repeatability", the output shaft stop position is measured by performing positioning at a position 7 times in the same direction. This measurement is performed at 4 locations on the output shaft and the maximum error is found. The measurement value is expressed as an angle which is 1/2 the maximum error with ± attached. (JIS B 6201-1987)

CG type		Unit [Second]			
Reduction ratio	Model	SHA20P	SHA25P	SHA32P	SHA40P
Ratio to full speed		±5	±5	±4	±4

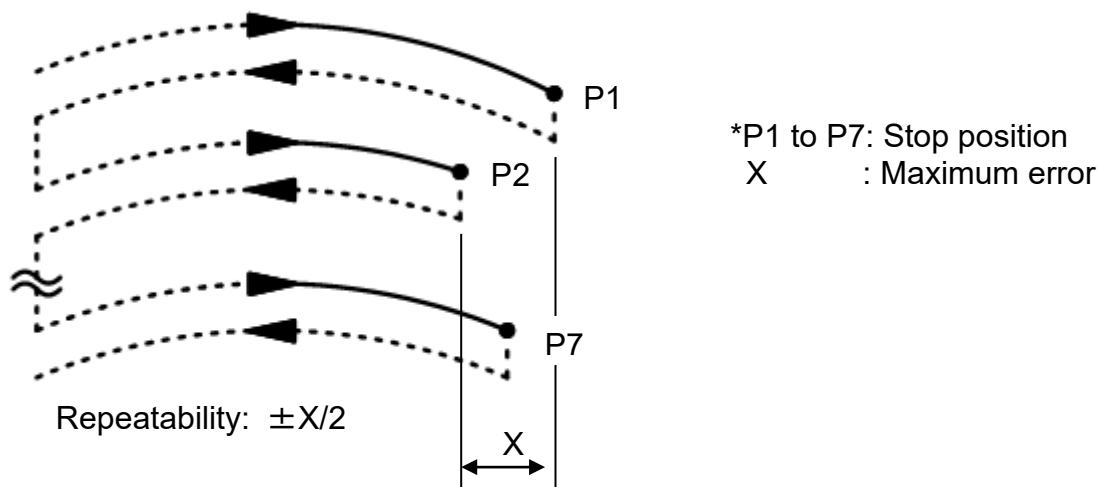

Reverse positional accuracy (CG type)

For the "reverse positional accuracy", the shaft is rotated beforehand in the forward (or reverse) direction and the stop position for that rotation is set as the reference position. An instruction is given to rotate the shaft in the same direction and from the stopped position, the same instruction is given in the reverse (or forward) direction and the difference between the stop position after this rotation and the reference position is measured.

The average value from repeating this 7 times in each direction is shown and the maximum value measured at the 4 locations on the output shaft is shown. (JIS B 6201-1987)

CG type		Unit [Second]			
Reduction ratio	Model	SHA20P	SHA25P	SHA32P	SHA40P
1:50		75	60	60	50
1:80 or more		30	25	25	20

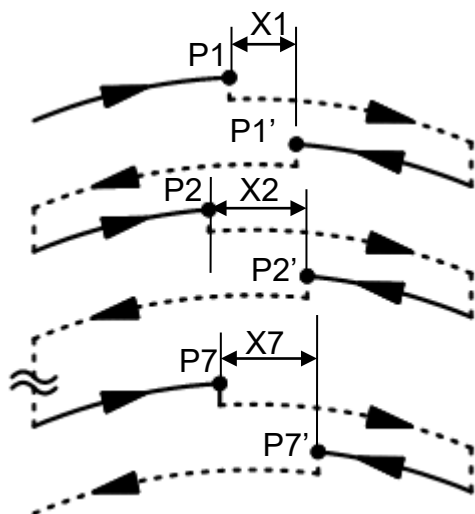

- *P1 to P7 : Stop position after forward rotation
- P1' to P7' : Stop position after reverse rotation
- X1 to X7 : Difference between the stop positions after forward and reverse rotations

Reverse positional accuracy: $|X1+X2+...+X7|/7$

1-9 Encoder specifications

Absolute encoders installed in SHA-P series are multi turn-type magnetic absolute encoders. This encoder consists of a detector (17 bits) for detecting the position per motor shaft revolution, and a cumulative counter (16 bits) for detecting the number of revolutions.

This encoder constantly detects the absolute output position and stores it by means of the backup battery, regardless of whether the power supply for the servo amplifier or external controller is turned ON/OFF. Accordingly, once the origin is detected when the machine is installed, originating is not required after subsequent power ON operations. This facilitates the recovery operation after a power failure or breakdown.

In addition, while the power is ON, the cumulative counter portion that detects the single revolution absolute position and the number of revolutions is a dual-redundant system in which a matching check is always performed on data, and this highly reliable design allows for encoder errors to be self-detected should they occur.

It is recommended that you replace the battery while the servo amplifier is receiving power.

Note that if servo amplifier (A6) parameter setting Pr.0.15 is set to "1", the encoder can be operated as an incremental system.

Specifications

Type*1	Magnetic sensor/electronic battery backup type (Single rotation optic, multiple revolution magnetic sensor/electronic battery backup type)
Resolution per motor revolution	17 bits (2^{17} : 131072 pulses)
Maximum cumulative motor shaft revolutions	16 bits (2^{16} : 65536 revolutions cumulatively)
Maximum permissible motor shaft rotational speed	7000 r/min*2
Safety/redundancy	<ul style="list-style-type: none"> • Check method in which two identical single revolution detectors are compared • Check method in which two identical cumulative revolution counters are compared
Backup time by external battery	1 year*3 (when power is not supplied)
Backup time by internal battery*4	30 minutes (after 3 hours of charge, ambient temperature of 25 °C, axis stopped) (For backup while the servo amplifier and encoder are disconnected briefly)

*1: Model No. 20 is equipped with an optical encoder; other models are equipped with a magnetic encoder.

*2: This is the rotation speed limit of the encoder and is different from the rotation speed that the motor can drive.

*3: The value is obtained with the motor axis stopped. Frequent movement of the motor axis with no power supply would cause the external battery to drain quickly.

*4: This function is only available for SHA20P. Other models do not have this function.

Resolution of output shaft

Encoder resolution		17 bits (2^{17} : 131072 pulses)				
Reduction ratio		1:51	1:81	1:101	1:121	1:161
Resolution of output shaft	Pulse/rev	6684672	10616832	13238272	15859712	21102592
Resolvable angle per pulse	Sec.	Approx. 0.2	Approx. 0.12	Approx.0.1	Approx. 0.082	Approx. 0.061
Reduction ratio		1:50	1:80	1:100	1:120	1:160
Resolution of output shaft	Pulse/rev	6553600	10485760	13107200	15728640	20971520
Resolvable angle per pulse	Sec.	Approx. 0.2	Approx. 0.12	Approx.0.1	Approx. 0.082	Approx. 0.062

Differences in specifications from Panasonic servo motor with 17-bit absolute encoder

The encoder installed in the SHA-P series uses a different format, meaning that its specifications are slightly different. Differences and points of note are shown in the table below.

Item		Specifications			Notices	
		SHA-P series		MINAS A6 series		
		Size No 20	Size No 25 and later	MINAS A6N series MINAS A6B series		
Battery alarm voltage	V	3.07 to 3.33	3.05 to 3.25	3.0 to 3.2	None	
Power-on stand-by time	s	0.5 or less	5 or less	1.5 or less	When combining with size No. 25 or higher, it is necessary to change amplifier parameter Pr 6.18 [Power ON wait time]. If this is not changed, then at power supply ON, error 21.0 will be generated. Change the wait time, with (1.5 + set value), from the amplifier factory set value of "0" (default value) to "3.5". If the set value is smaller than 3.5, the amplifier outputs error code 21.0 (encoder communication disconnect error protection).	
Current consumption during normal operation	TYP	mA	65	105	80	No problem up to 20 m with the standard encoder cable. Separate examination required for special specifications.
	MAX		100	180	110	
Current consumption during backup (when axis stopped)	TYP	μA	30	25	60	Careful consideration required when calculating battery life.
	MAX		35	70	80	
Current consumption during backup (when axis rotating)	TYP	μA	30	285	180	
	MAX		35	350	—	
Overspeed detection	—		In normal operation At backup	At backup	Careful consideration required for responses during abnormal operation.	

1-10 Rigidity

Moment stiffness

The moment stiffness refers to the torsional stiffness when a moment load is applied to the output shaft of the actuator (shown in the figure).

For example, when a load is applied to the end of an arm attached on the output shaft of the actuator, the face of the output shaft of the actuator tilts in proportion to the moment load. The moment stiffness is expressed as the load/gradient angle.

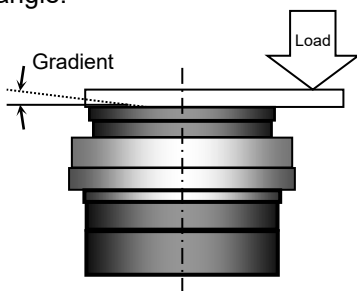

Item \ Model		SHA20P	SHA25P	SHA32P	SHA40P	SHA45P	SHA58P	SHA65P
Reduction ratio		1:50 or more	1:50 or more	1:50 or more	1:50 or more	1:51 or more	1:81 or more	1:81 or more
Moment stiffness	N·m/rad	25.2×10^4	39.2×10^4	100×10^4	179×10^4	257×10^4	531×10^4	741×10^4
	kgf·m/rad	25.7×10^3	40×10^3	102×10^3	183×10^3	262×10^3	542×10^3	756×10^3
	kgf·m/arc-min	7.5	11.6	29.6	53.2	76.3	158	220



Do not apply torque, load or thrust to the sleeve (hollow shaft) directly.

The sleeve (hollow shaft) is adhered to the output rotary shaft. Accordingly, the adhered sleeve may be detached from the output rotary shaft if a torque or load is applied to the sleeve (hollow shaft).

Do not apply any torque, moment load or thrust load directly to the sleeve (hollow shaft).

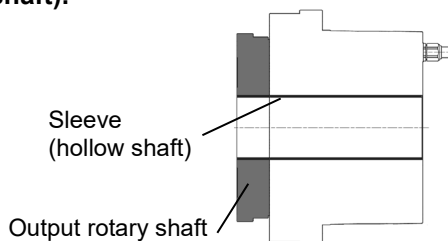

Torsional rigidity

If a torque is applied to the output shaft of the actuator with the servo locked, the output shaft generates a torsional stress roughly in proportion to the torque.

The upper right figure shows the torsional angle of the output shaft when a torque starting from zero and increased to positive side [+T₀] and negative side [-T₀] is applied to the output shaft. This is called [torque vs. torsional angle] diagram, which typically follows a loop 0→A→B→A'→B'→A. The torsional rigidity of SHA-P series actuator is expressed by the gradient of this [torque vs. torsional angle diagram] representing a spring constant (unit: N·m/rad).

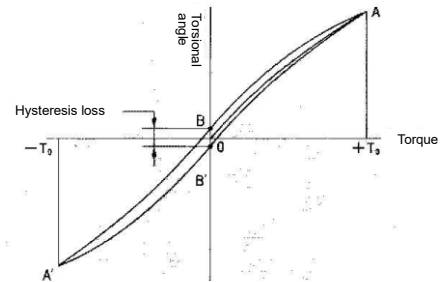

As shown by lower right figure, this [torque vs. torsional angle] diagram is divided into three regions and the spring constants in these regions are expressed by K₁, K₂, and K₃, respectively.

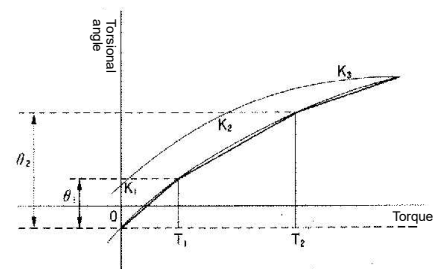

- K₁: Spring constant for torque region 0 to T₁
- K₂: Spring constant for torque region T₁ to T₂
- K₃: Spring constant for torque region over T₂

The torsional angle for each region is expressed as follows:

- Range where torque T is T₁ or below: $\varphi = \frac{T}{K_1}$ * φ : Torsional angle
- Range where torque T is T₁ to T₂: $\varphi = \theta_1 + \frac{T - T_1}{K_2}$
- Range where torque T is T₂ to T₃: $\varphi = \theta_2 + \frac{T - T_2}{K_3}$

The table below shows the averages of T₁ to T₃, K₁ to K₃, and θ_1 to θ_2 for each actuator.

Model		SHA20P		SHA25P		SHA32P		SHA40P	
Reduction ratio		1:50 1:51	1:80 or more	1:50 1:51	1:80 or more	1:50 1:51	1:80 or more	1:50 1:51	1:80 or more
T ₁	N·m	7.0		14		29		54	
	kgf·m	0.7		1.4		3.0		5.5	
K ₁	×10 ⁴ N·m/rad	1.3	1.6	2.5	3.1	5.4	6.7	10	13
	kgf·m/arc-min	0.38	0.47	0.74	0.92	1.6	2.0	3.0	3.8
θ ₁	×10 ⁻⁴ rad	5.2	4.4	5.5	4.4	5.5	4.4	5.2	4.1
	arc-min	1.8	1.5	1.9	1.5	1.9	1.5	1.8	1.4
T ₂	N·m	25		48		108		196	
	kgf·m	2.5		4.9		11		20	
K ₂	×10 ⁴ N·m/rad	1.8	2.5	3.4	5.0	7.8	11	14	20
	kgf·m/arc-min	0.52	0.75	1.0	1.5	2.3	3.2	4.2	6.0
θ ₂	×10 ⁻⁴ rad	15.4	11.3	15.7	11.1	15.7	11.6	15.4	11.1
	arc-min	5.3	3.9	5.4	3.8	5.4	4.0	5.3	3.8
K ₃	×10 ⁴ N·m/rad	2.3	2.9	4.4	5.7	9.8	12	18	23
	kgf·m/arc-min	0.67	0.85	1.3	1.7	2.9	3.7	5.3	6.8

Model		SHA45P		SHA58P	SHA65P
Reduction ratio		1:51	1:81 or more	1:81 or more	1:81 or more
T ₁	N·m	76		168	235
	kgf·m	7.8		17	24
K ₁	×10 ⁴ N·m/rad	15	18	40	54
	kgf·m/arc-min	4.3	5.4	12	16
θ ₁	×10 ⁻⁴ rad	5.2	4.1	4.1	4.4
	arc-min	1.8	1.4	1.4	1.5
T ₂	N·m	275		598	843
	kgf·m	28		61	86
K ₂	×10 ⁴ N·m/rad	20	29	61	88
	kgf·m/arc-min	6.0	8.5	18	26
θ ₂	×10 ⁻⁴ rad	15.1	11.1	11.1	11.3
	arc-min	5.2	3.8	3.8	3.9
K ₃	×10 ⁴ N·m/rad	26	33	71	98
	kgf·m/arc-min	7.6	9.7	21	29

The table below shows reference torque values calculated for different torsional angle. Unit [N·m]

Model	SHA20P		SHA25P		SHA32P		SHA40P	
Reduction ratio	1:50 1:51	1:80 or more	1:50 1:51	1:80 or more	1:50 1:51	1:80 or more	1:50 1:51	1:80 or more
2 arc-min	8	11	15	21	31	45	63	88
4 arc-min	19	25	35	51	77	108	144	208
6 arc-min	30	43	56	84	125	178	233	342

Model	SHA45P		SHA58P	SHA65P
Reduction ratio	1:51	1:81 or more	1:81 or more	1:81 or more
2 arc-min	88	124	273	360
4 arc-min	205	293	636	876
6 arc-min	336	483	1050	1450

1-11 Rotation direction

SG type

With the factory settings, the rotation direction is defined as clockwise (CW) as viewed from the output shaft when a command is given from the MINAS A6 servo amplifier in the direction of rising position addresses.

The method of changing the rotation direction varies depending on the servo amplifier communication I/F.

A6S "Analog/Pulse" and A6N "RTEX" can be changed with Pr0.00 of PANATERM.

For A6B "EtherCAT", change the set value of EtherCAT Object Index 607Eh-00h (Polarity) on the host device.

For details, refer to the Functional Specification of the servo amplifier technical documentation from Panasonic Corporation.

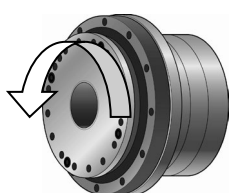

CCW (counterclockwise) rotation direction

Rotation direction setting

Pr0.00 set value (A6S, A6N)	607Eh (Polarity) set value (A6B)	Actuator rotation direction	
		During forward direction command	During reverse direction command
0	224	CW direction (clockwise)	CCW direction (counterclockwise)
1	0	CCW direction (counterclockwise)	CW direction (clockwise)

CG type

With the factory settings, the rotation direction is defined as counterclockwise (CCW) as viewed from the output shaft when a pulse train is applied from the MINAS A6 servo amplifier in the direction of rising position addresses.

The method of changing the rotation direction varies depending on the servo amplifier communication I/F.

A6S "Analog/Pulse" and A6N "RTEX" can be changed with Pr0.00 of PANATERM.

For A6B "EtherCAT", change the set value of EtherCAT Object Index 607Eh-00h (Polarity) on the host device.

For details, refer to the Functional Specification of the servo amplifier technical documentation from Panasonic Corporation.

Rotation direction setting

Pr0.00 set value (A6S, A6N)	607Eh (Polarity) set value (A6B)	Actuator rotation direction	
		During forward direction command	During reverse direction command
0	224	CCW direction (counterclockwise)	CW direction (clockwise)
1	0	CW direction (clockwise)	CCW direction (counterclockwise)

1-12 Shock resistance

The shock resistance of the actuator is as follows, and this value is the same in up/down, left/right and front/rear directions:

Impact acceleration: 300 m/s^2

In our shock resistance test, the actuator is tested 3 times in each direction. Actuator operation is not guaranteed in applications where impact exceeding the above value is constantly applied.

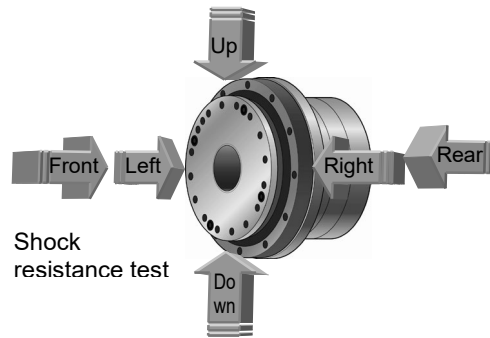

1-13 Resistance to vibration

The resistance to vibration of the actuator is as follows, and this value is the same in up/down, left/right and front/rear directions:

Vibration acceleration: 25 m/s^2 (frequency: 10 to 400 Hz)

In our test, the actuator is tested for 2 hours in each direction at a vibration frequency sweep period of 10 minutes.

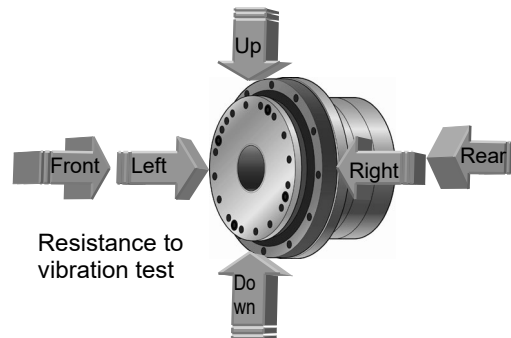

1-14 Operable range

The graph on the next page indicates the operable range when SHA-P series actuator (Combination with MINAS A6 servo amplifier) is selected. For details, refer to [Chapter 2 Selection guidelines].

1. Continuous motion range

The range allows continuous operation for the actuator.

2. 50 % duty motion range

This range indicates the torque rotation speed which is operable in the 50 % duty operation (the ratio of operating time and delay time is 50:50).

3. Motion range during acceleration and deceleration

This range indicates the torque rotation speed which is operable momentarily. The range allows instantaneous operation like acceleration and deceleration, usually.

The continuous and 50 % duty motion ranges in each graph are measured on the condition where the radiation plate specified in the graph is installed.

Caution

- When using the product at constant load or in one direction continuously, it may cause lubrication problems. Contact our sales office if the product will be used in this way.
 - The continuous motion range and 50 % duty motion range represent allowable ranges where the actuator installed on a specified aluminum radiation plate is operated under natural air cooling. If the radiation area of the mounting member is small or heat conduction of the material is poor, adjust the operating conditions to keep the rise in the actuator's ambient temperature to 40 K or less as a guide.
-

**SG type
SHA20P**

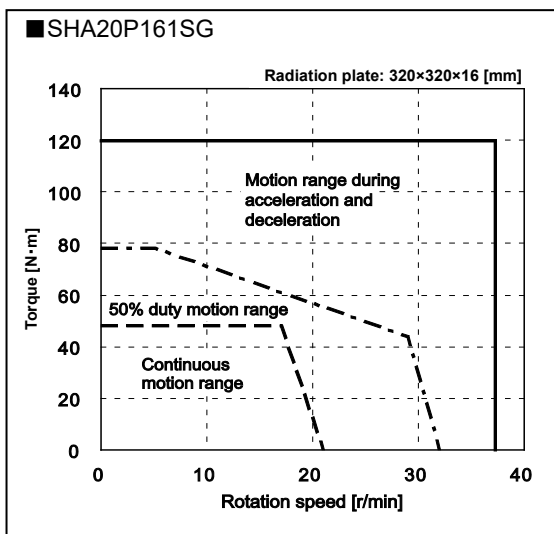
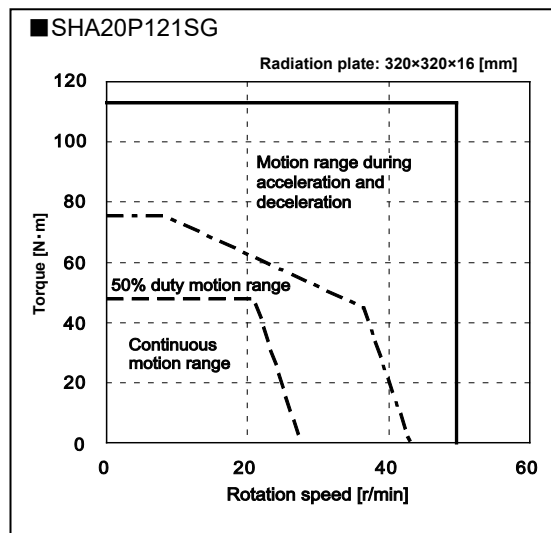
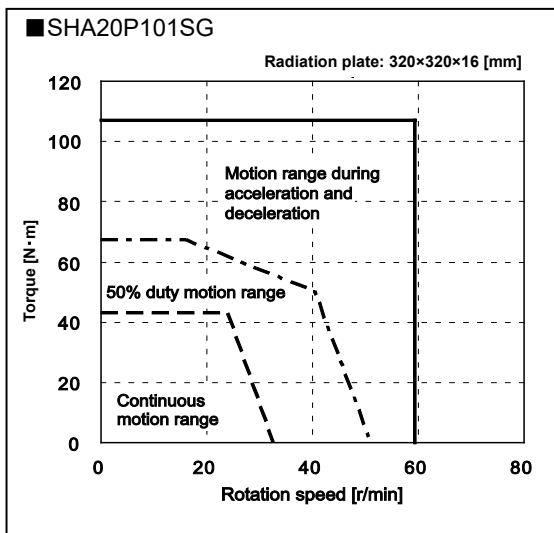
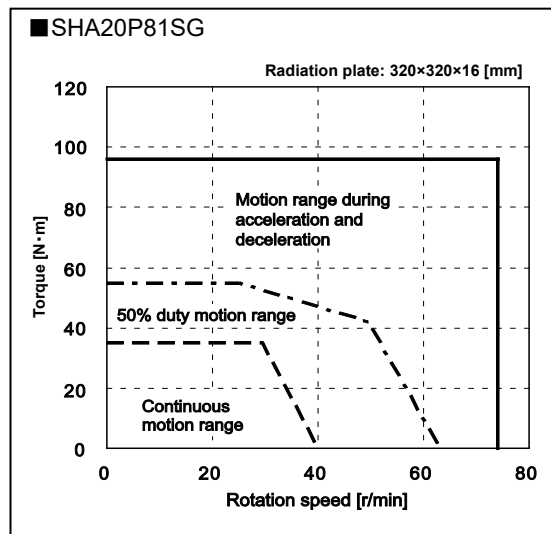
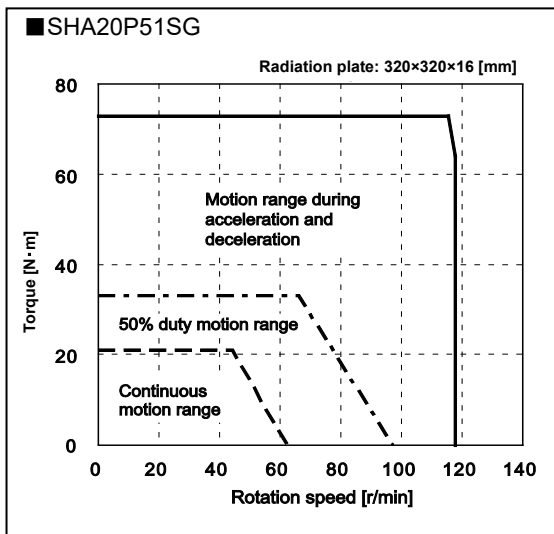

Note1: Values in the continuous motion range and 50 % duty range are measured on the condition where an aluminum radiation plate of the dimensions specified in the upper right of the graph is installed.
 Note2: The graph shows typical values of 3-phase 200 VAC and single-phase 200 VAC.

**SG type
SHA25P**

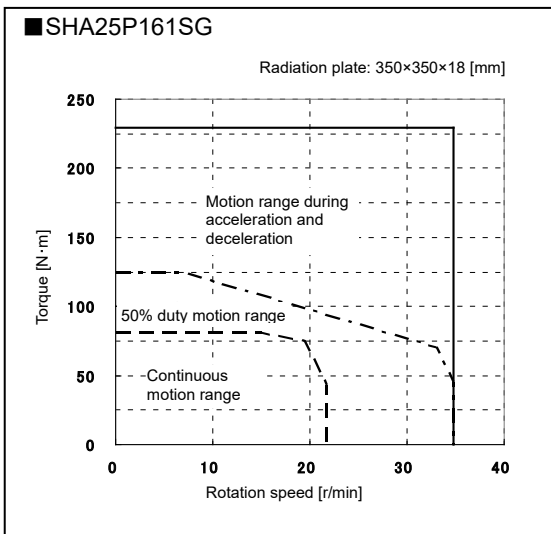
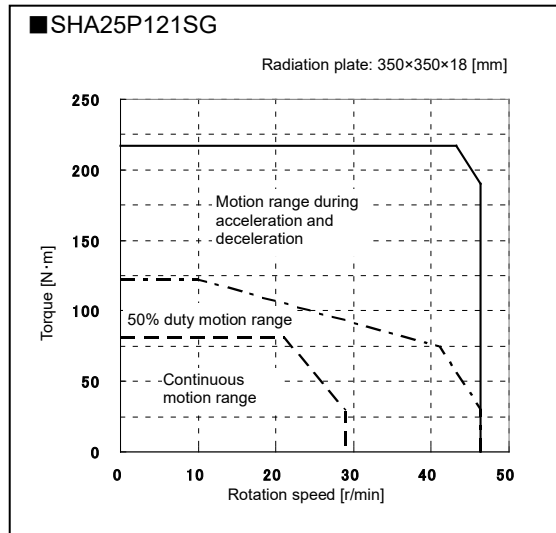
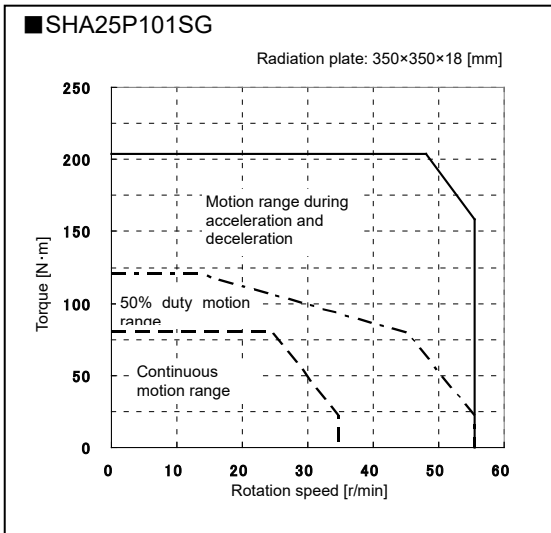
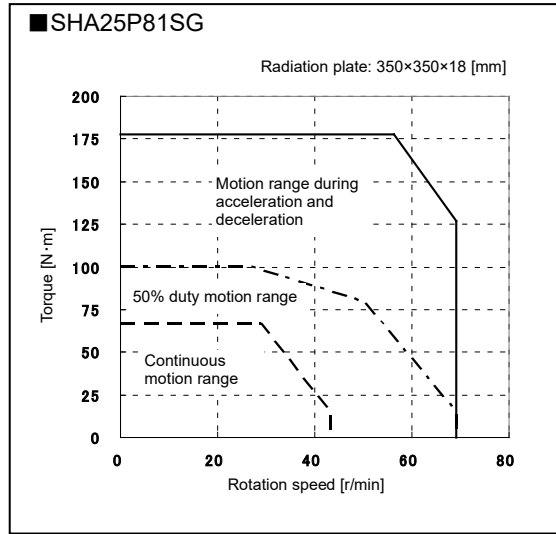
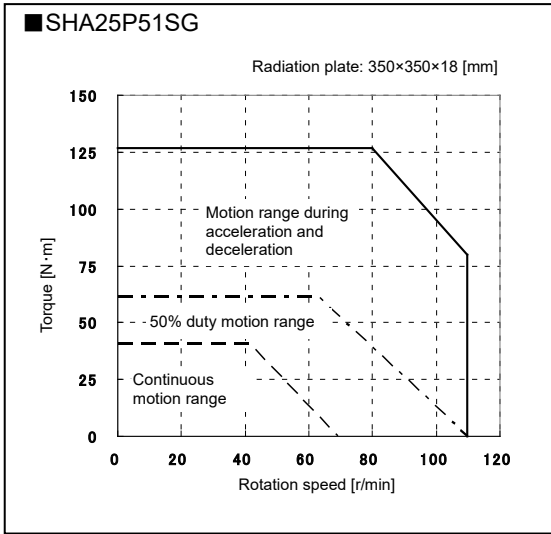

Note1: Values in the continuous motion range and 50 % duty range are measured on the condition where an aluminum radiation plate of the dimensions specified in the upper right of the graph is installed.
 Note2: The graph shows typical values of 3-phase 200 VAC and single-phase 200 VAC.

**SG type
SHA32P**

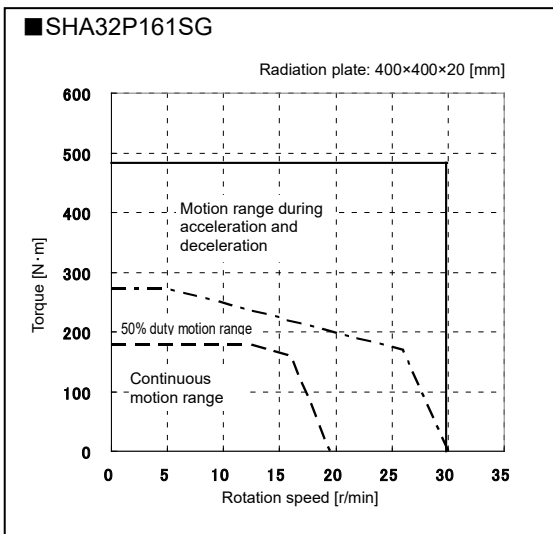
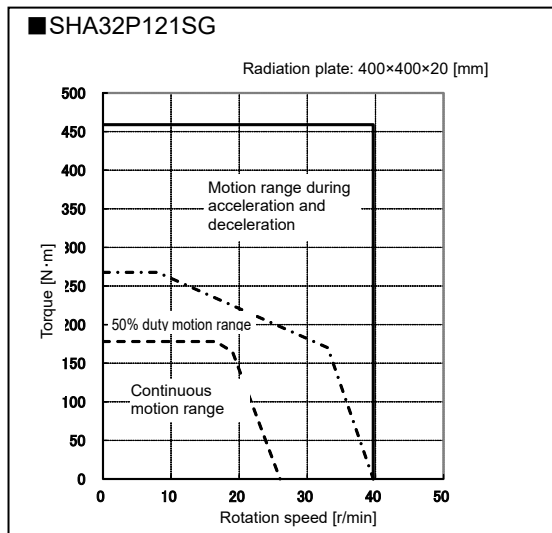
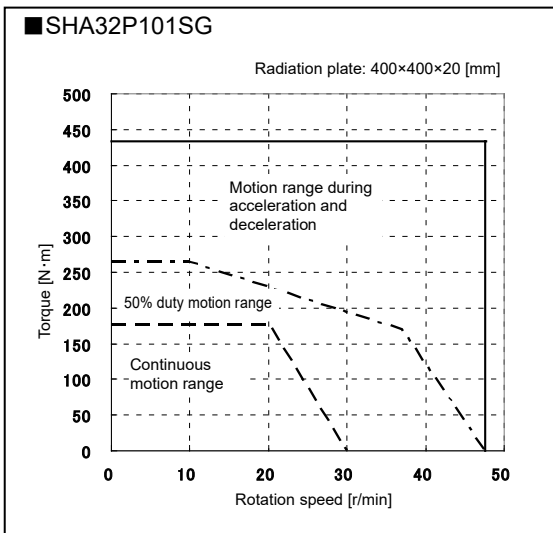
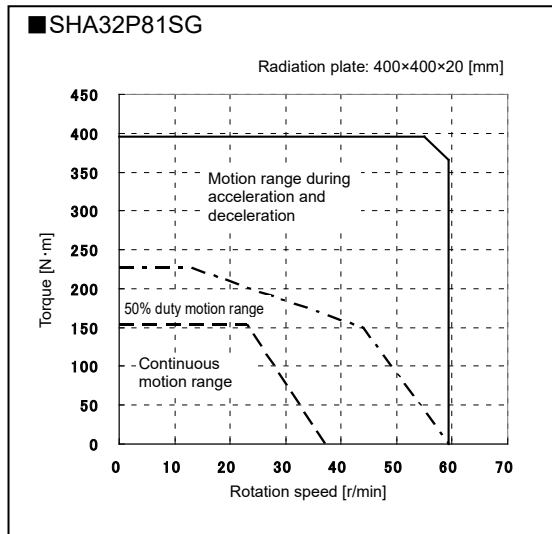
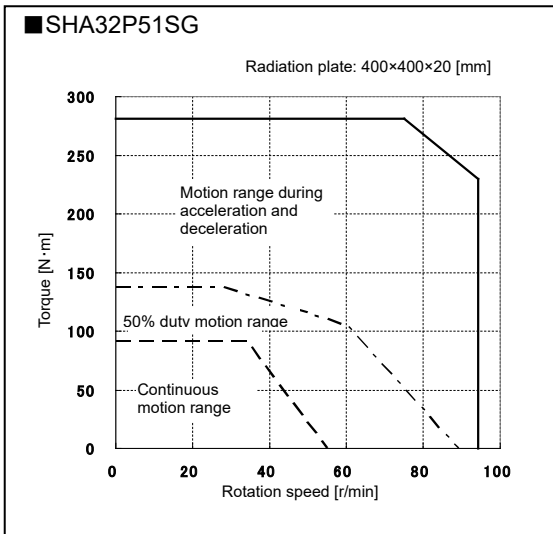

Note1: Values in the continuous motion range and 50 % duty range are measured on the condition where an aluminum radiation plate of the dimensions specified in the upper right of the graph is installed.
 Note2: The graph shows typical values of 3-phase 200 VAC and single-phase 200 VAC.

**SG type
SHA40P**

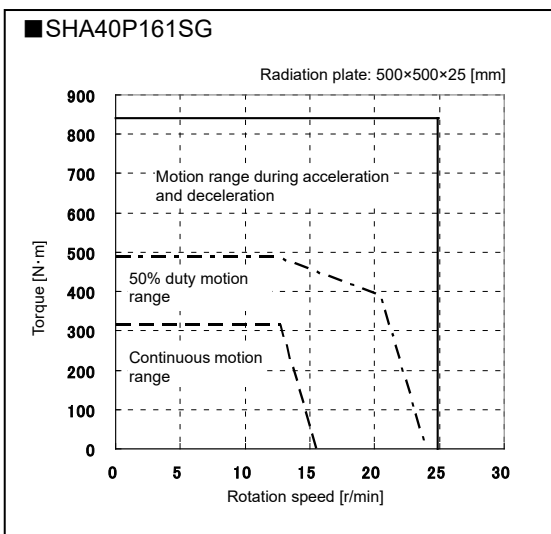
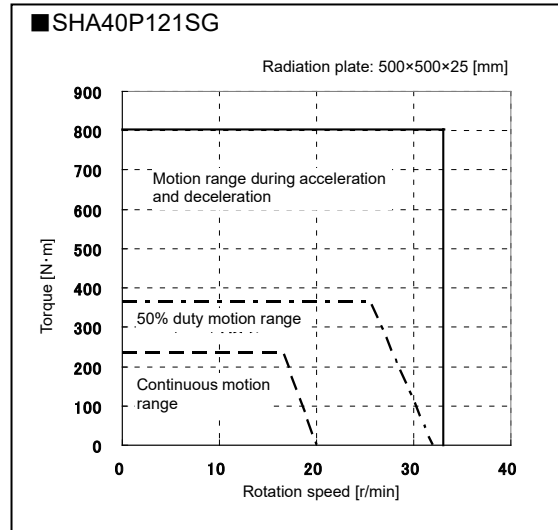
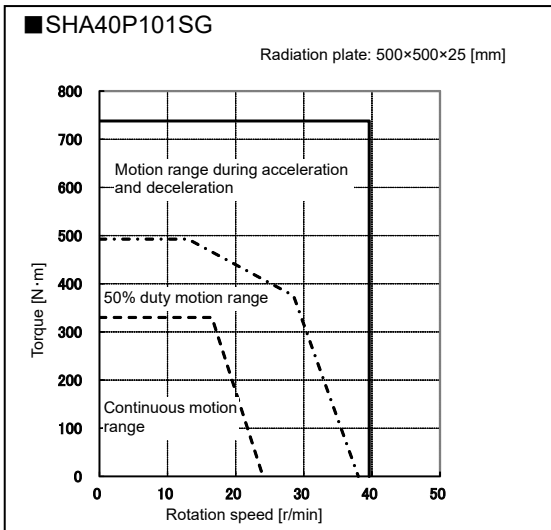
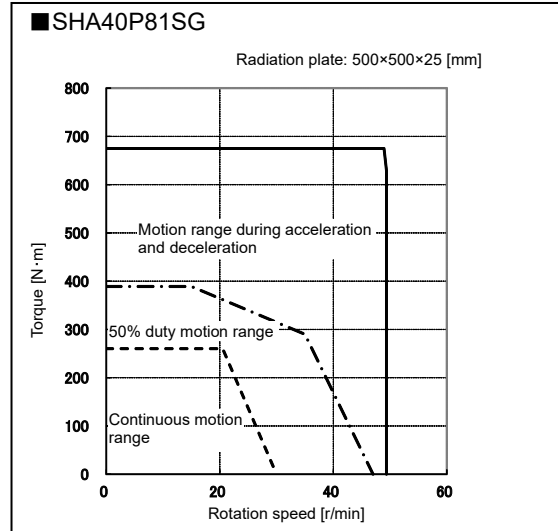
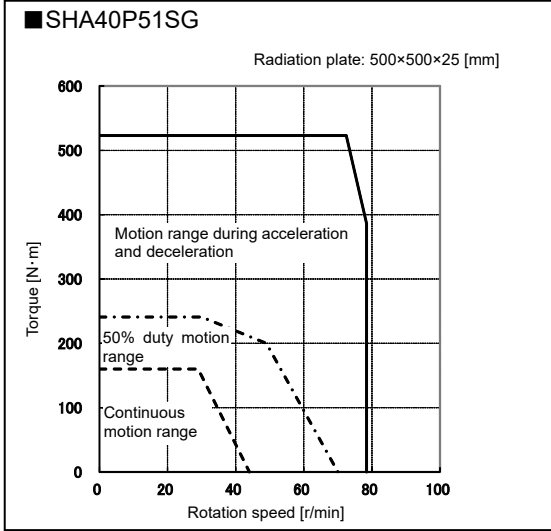

Note1: Values in the continuous motion range and 50 % duty range are measured on the condition where an aluminum radiation plate of the dimensions specified in the upper right of the graph is installed.
Note2: The graph shows typical values of 3-phase 200 VAC.

**SG type
SHA45P**

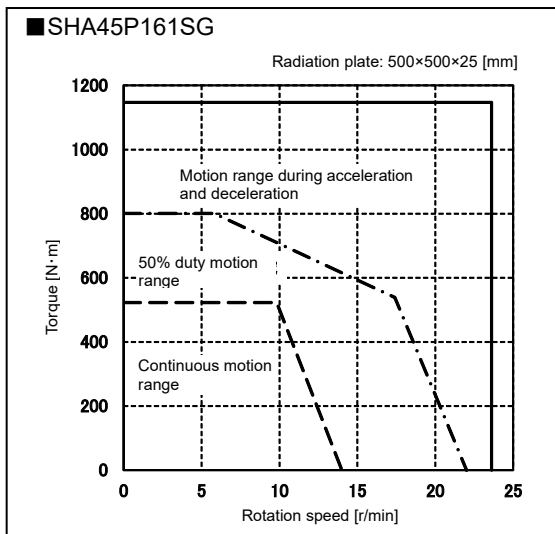
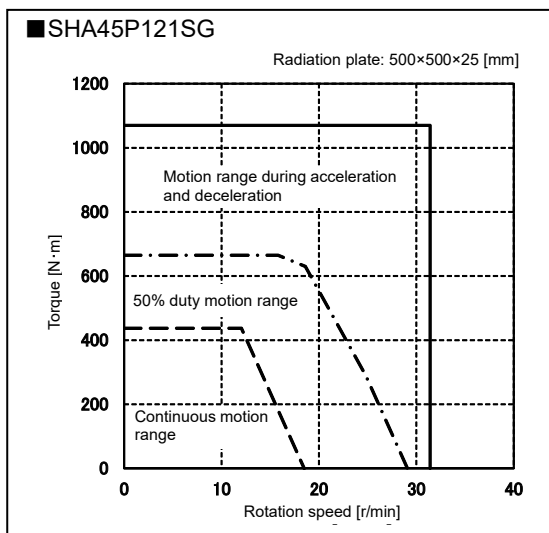
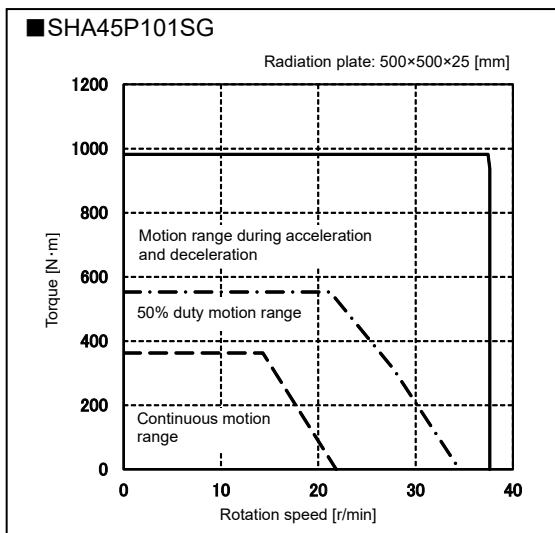
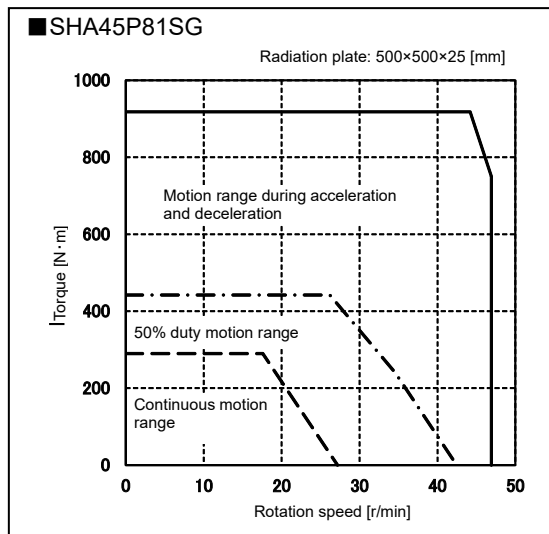
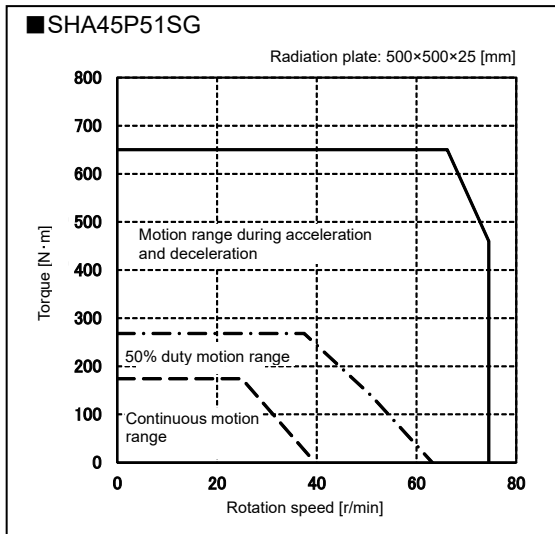

Note1: Values in the continuous motion range and 50 % duty range are measured on the condition where an aluminum radiation plate of the dimensions specified in the upper right of the graph is installed.
 Note2: The graph shows typical values of 3-phase 200 VAC.

**SG type
SHA58P**

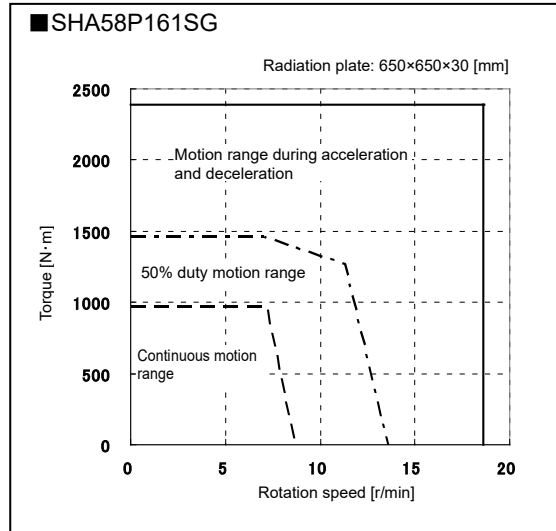
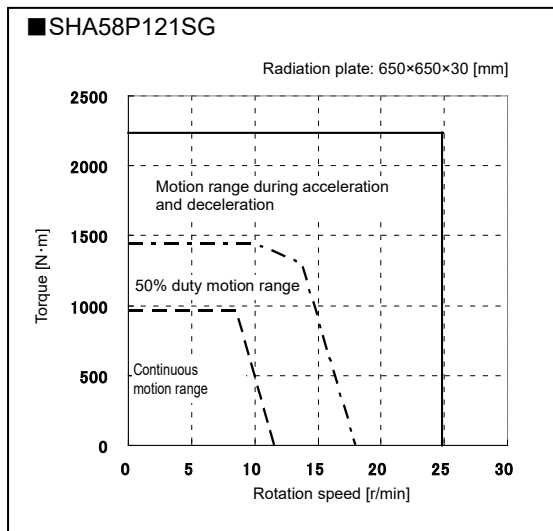
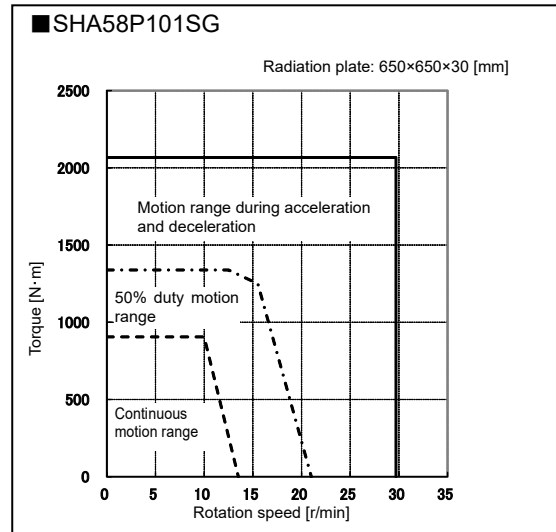
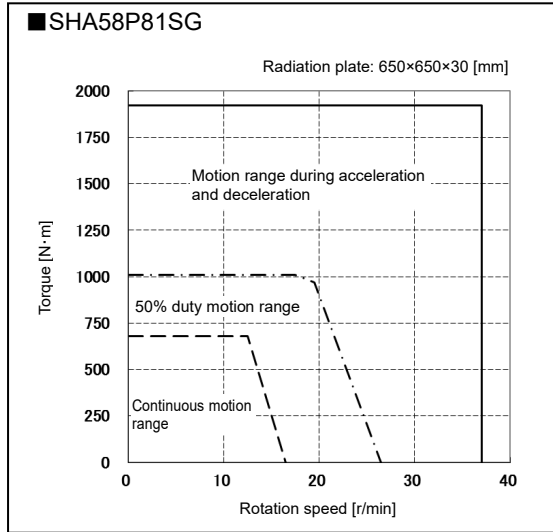

Note1: Values in the continuous motion range and 50 % duty range are measured on the condition where an aluminum radiation plate of the dimensions specified in the upper right of the graph is installed.

Note2: The graph shows typical values of 3-phase 200 VAC.

**SG type
SHA65P**

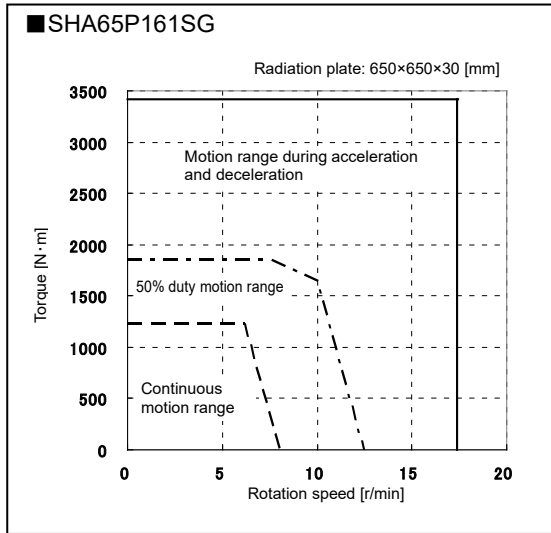
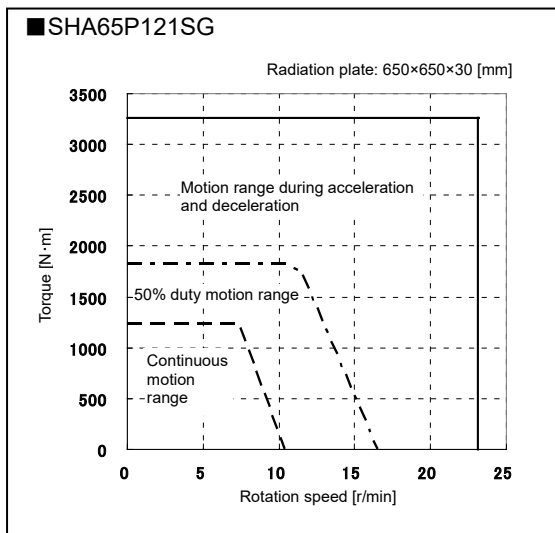
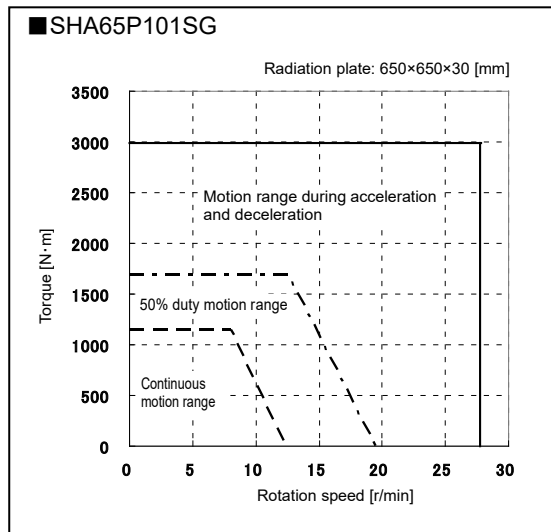
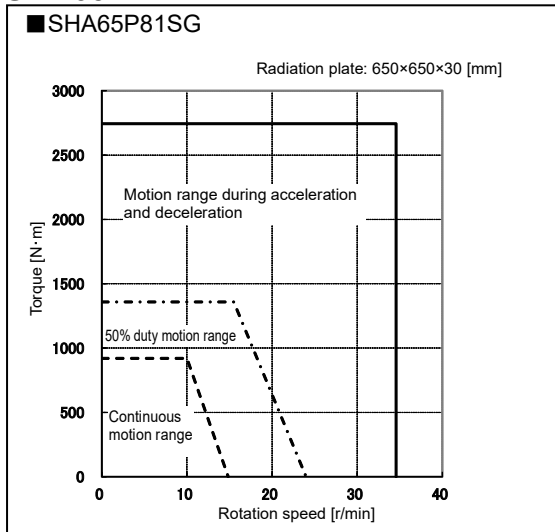

Note1: Values in the continuous motion range and 50 % duty range are measured on the condition where an aluminum radiation plate of the dimensions specified in the upper right of the graph is installed.
 Note2: The graph shows typical values of 3-phase 200 VAC.

**CG type
SHA20P**

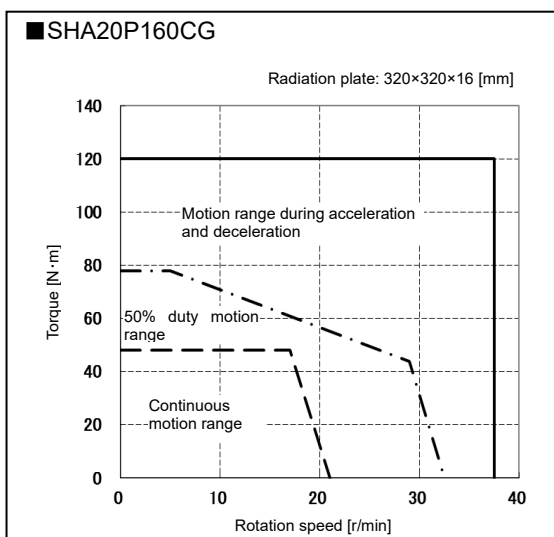
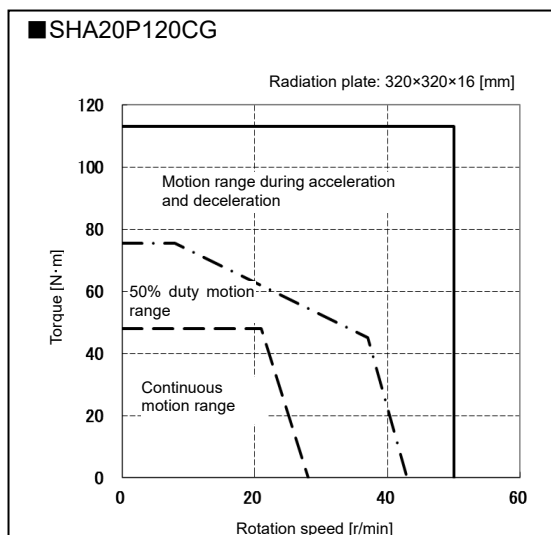
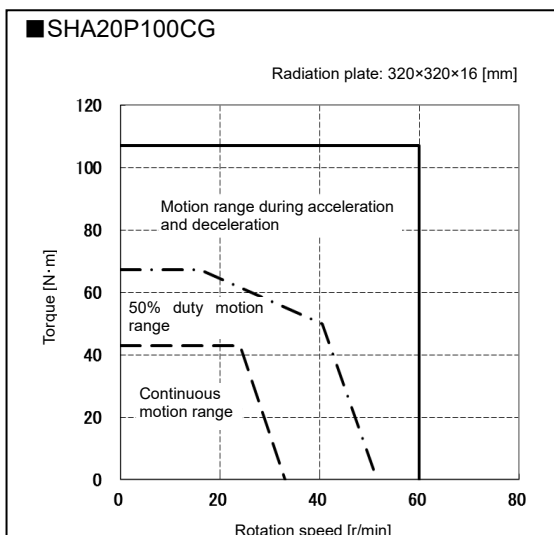
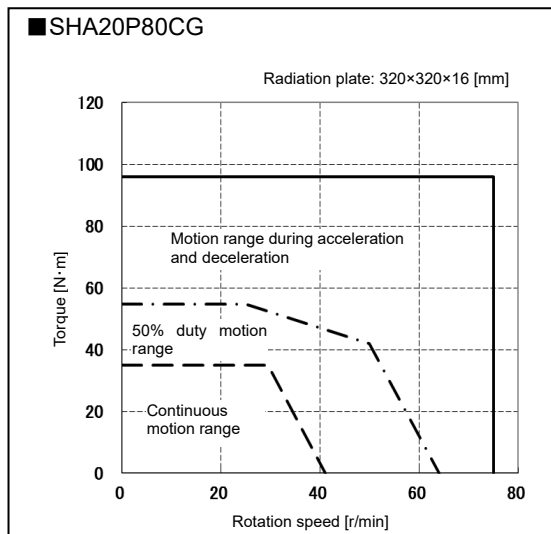
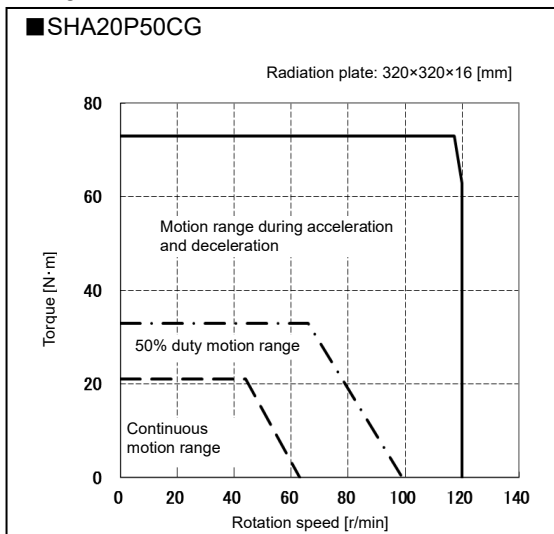

Note1: Values in the continuous motion range and 50 % duty range are measured on the condition where an aluminum radiation plate of the dimensions specified in the upper right of the graph is installed.
 Note2: The graph shows typical values of 3-phase 200 VAC and single-phase 200 VAC.

**CG type
SHA25P**

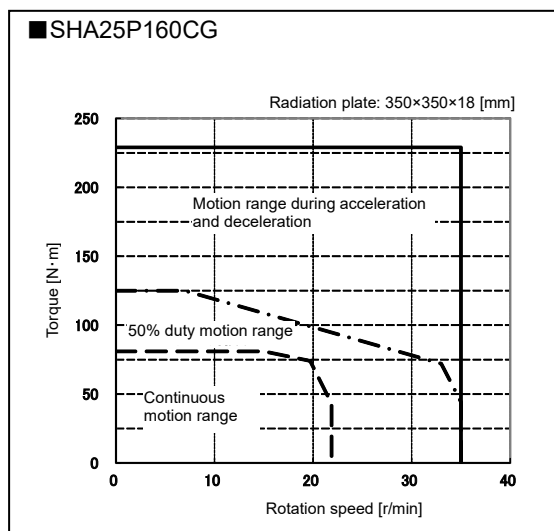
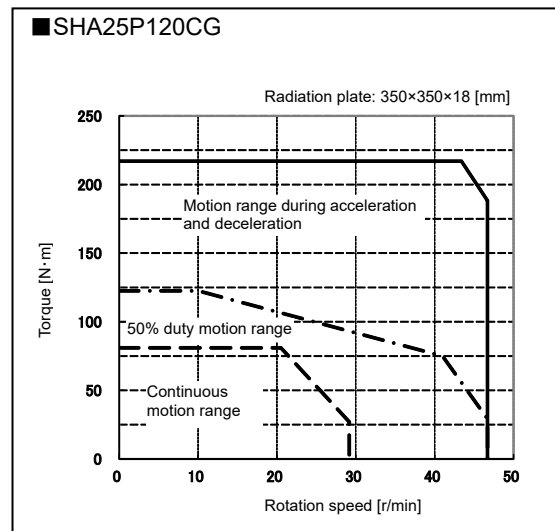
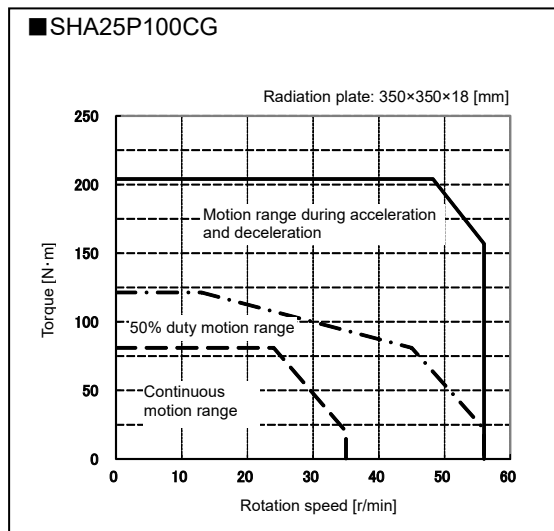
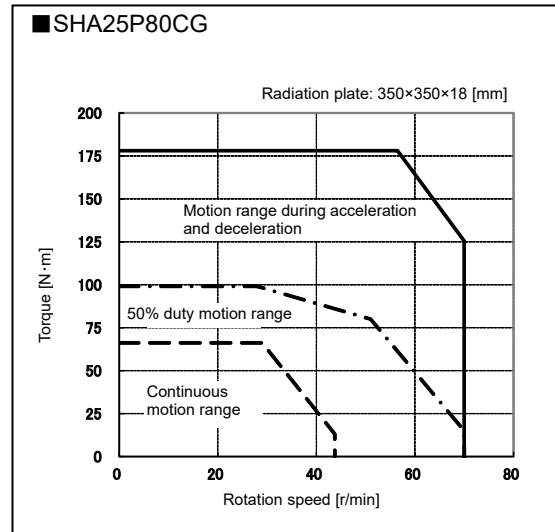
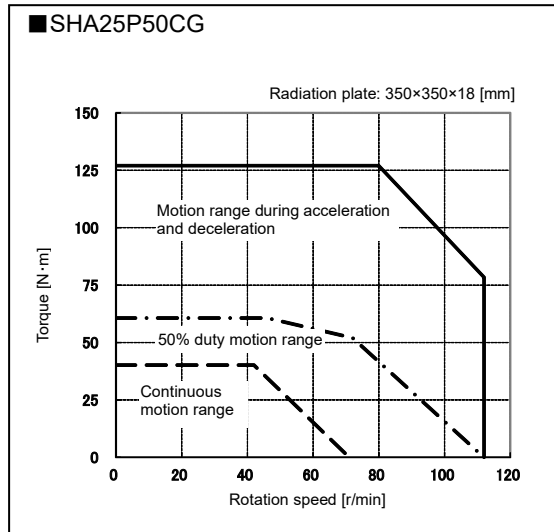

Note1: Values in the continuous motion range and 50 % duty range are measured on the condition where an aluminum radiation plate of the dimensions specified in the upper right of the graph is installed.
 Note2: The graph shows typical values of 3-phase 200 VAC and single-phase 200 VAC.

**CG type
SHA32P**

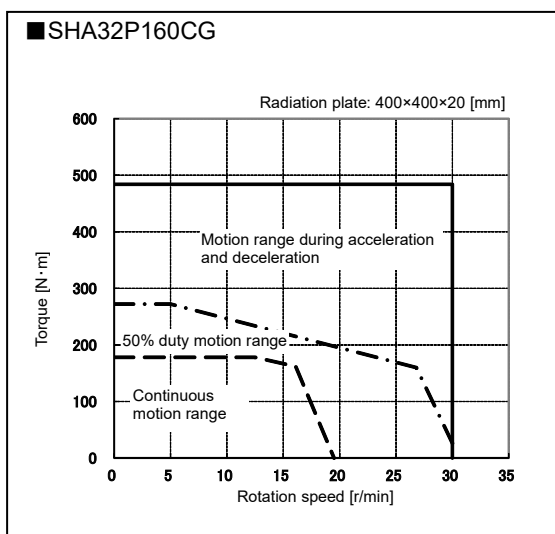
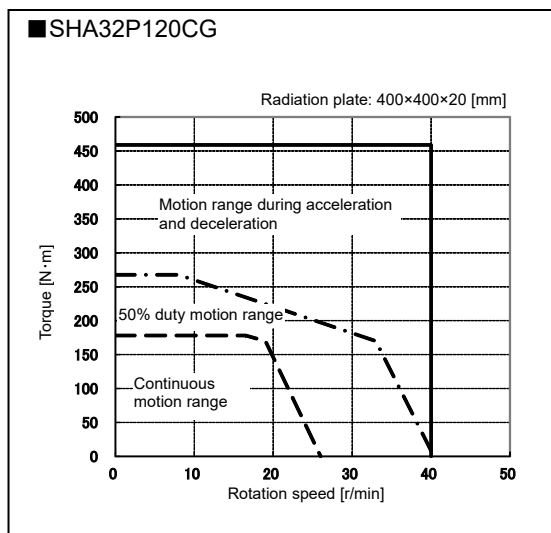
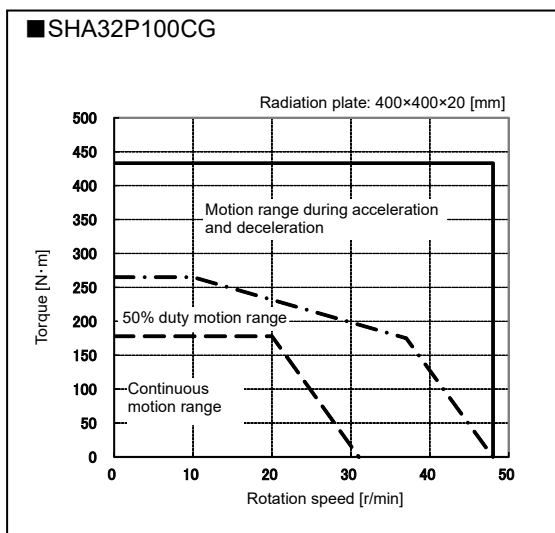
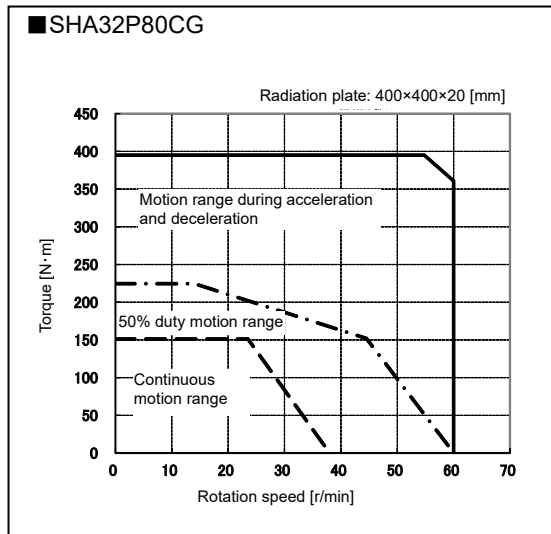
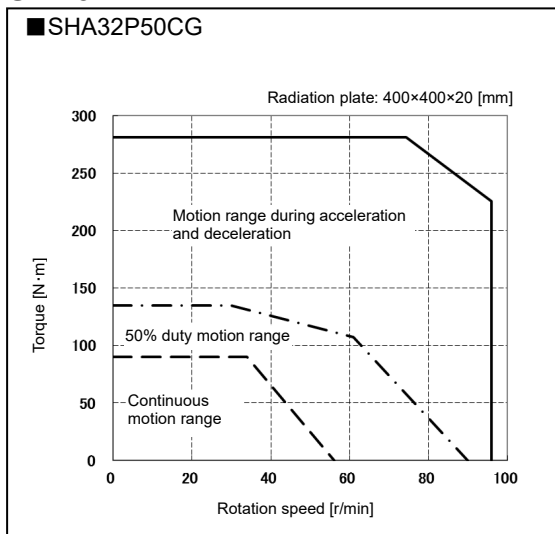

Note1: Values in the continuous motion range and 50 % duty range are measured on the condition where an aluminum radiation plate of the dimensions specified in the upper right of the graph is installed.
 Note2: The graph shows typical values of 3-phase 200 VAC and single-phase 200 VAC.

CG type
SHA40P

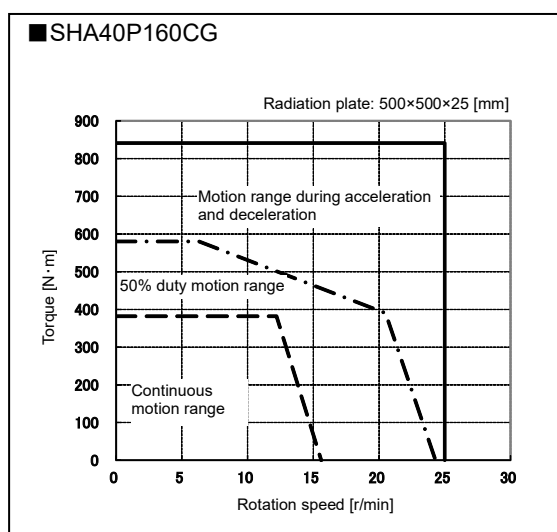
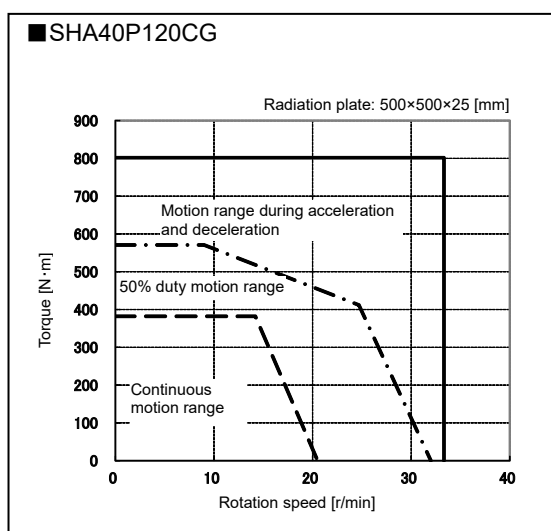
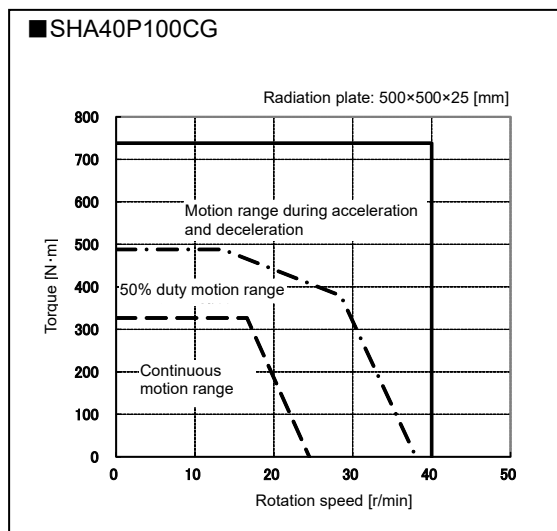
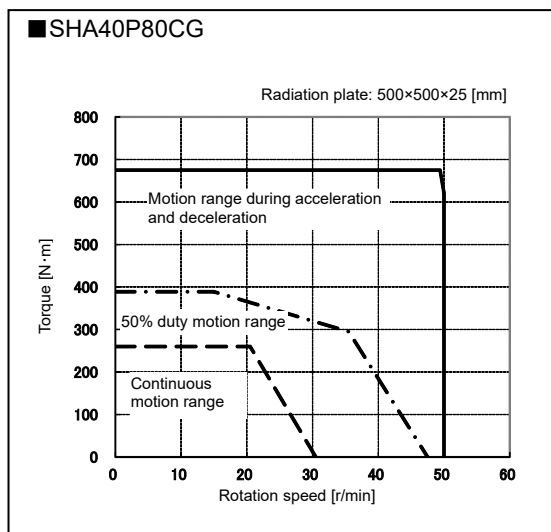
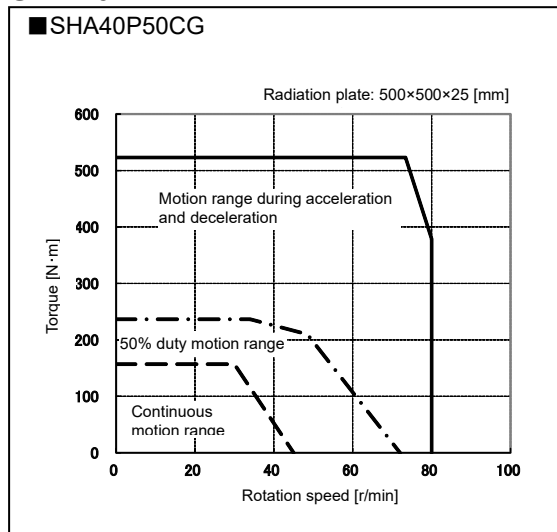

Note1: Values in the continuous motion range and 50 % duty range are measured on the condition where an aluminum radiation plate of the dimensions specified in the upper right of the graph is installed.
 Note2: The graph shows typical values of 3-phase 200 VAC.

1-15 Cable specifications

The following tables show specifications of the motor and encoder cables of SHA-P series actuators.

Motor cable specifications

- Size Nos 20, 25, 32, 40, 45

Pin number	Color	Name	
		Without brake	With brake
1	Red	Motor phase-U	Motor phase-U
2	Black	Motor phase-V	Motor phase-V
3	White	Motor phase-W	Motor phase-W
4	Green/yellow	PE	PE
5	Blue	No connection	Brake
6	Yellow	No connection	Brake

- Connector pin layout

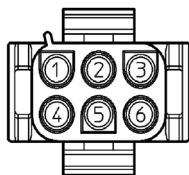

Connector model: 350715-1

Pin model:

	Size Nos 20, 25	Size Nos 32, 40
Motor UVW	350690-1	350547-1
Brake	350690-1	350690-1
Motor PE	350669-1	350669-1

by TE Connectivity (AMP)

- Size Nos 58, 65

Pin number	Name		Color (Extension cables)
	Without brake	With brake	
A	No connection	Brake	Blue
B	No connection	Brake	Yellow
C	No connection	No connection	—
D	Motor phase-U	Motor phase-U	Red
E	Motor phase-V	Motor phase-V	White
F	Motor phase-W	Motor phase-W	Black
G	PE	PE	Green/yellow
H	PE	PE	—
I	No connection	No connection	—

- Connector pin layout

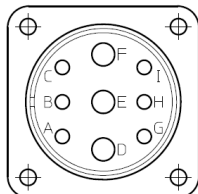

Connector model: CE05-2A24-11PGHS-D (by DDK)

Encoder cable specifications

- Size Nos 20, 25, 32, 40, 45

Pin number	Color	Signal name	Remarks
1	Orange	BAT+	Battery +
2	Gray	BAT-	Battery - (GND)
3	Shield	FG	
4	Yellow	PS	Serial signal differential output (+)
5	Blue	PS	Serial signal differential output (-)
6	—	No connection	
7	Red	E5 V	Power supply input +5 V
8	Black	E0 V	Power supply input 0 V (GND)
9	—	No connection	

- Connector pin layout

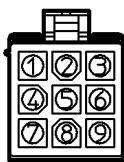

Connector model: 172169-1
 Pin model (Size No 20) : 770835-1 or 794059-1
 Pin model (Size Nos 25, 32, 40): 170363-1
 by TE Connectivity (AMP)

- Model Nos 58, 65

Pin number	Signal name	Remarks
1	E0 V	Power supply input 0 V (GND)
2	No connection	-
3	PS	Serial signal differential output (+)
4	E5 V	Power supply input +5 V
5	BAT-	Battery - (GND)
6	BAT+	Battery +
7	PS	Serial signal differential output (-)
8	No connection	-
9	FG	
10	No connection	-

- Connector pin layout

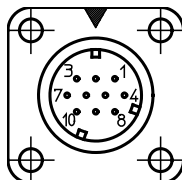

Connector model: JN2AS10ML2-R (by JAE)

Chapter 2

Selection guidelines

This chapter explains how to select a proper SHA-P series actuator.

2-1	SHA-P series selection	2-1
2-2	Change in load inertia moment	2-6
2-3	Verifying and examining load weights	2-7
2-4	Verifying operating conditions	2-11

2-1 SHA-P series selection

2

Selection guidelines

Allowable load inertia moment

To achieve high accuracy and performance, select SHA-P series actuator where the allowable load inertia moment specified for the applicable size No. is not exceeded.

Note that the allowable values in the table below should be referenced if you wish to shorten the transient vibration period during positioning or operate the actuator at a constant speed in a stable manner.

The operation is possible with the allowable value exceeded if the actuator is accelerated/decelerated gradually, commands given from the host to the servo amplifier are adjusted, or the servo amplifier's vibration suppression function is used.

Refer to [A-2 Calculating inertia moment] (PA-3) for the calculation of inertia moment.

SG type

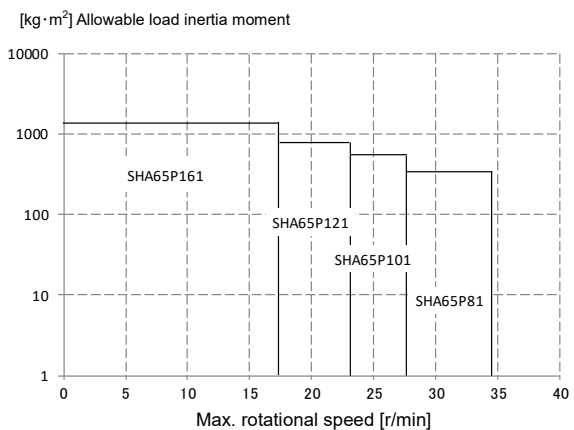
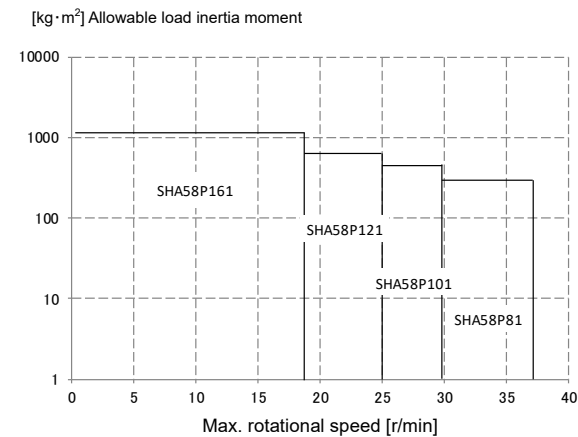
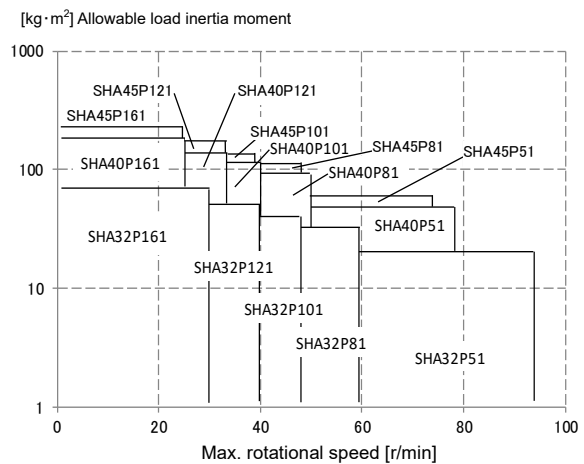
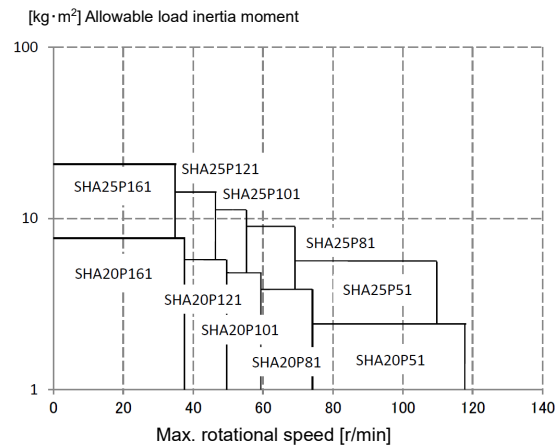

CG type

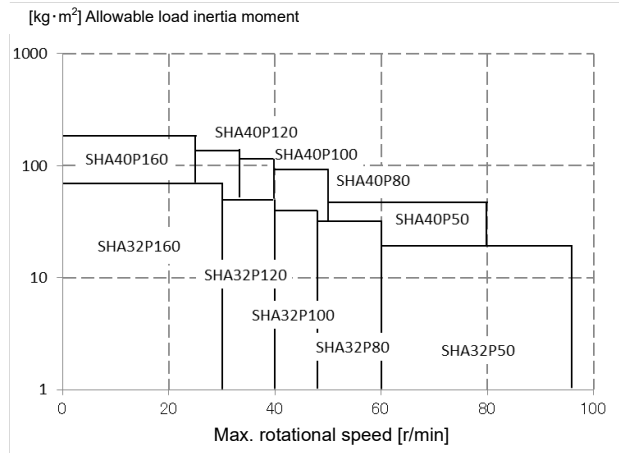
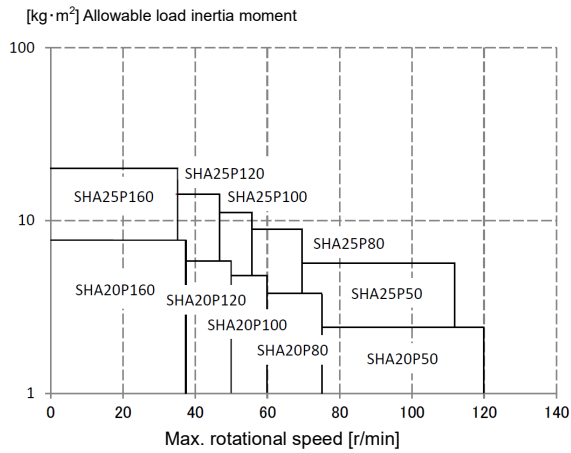

When temporarily selecting an actuator, make certain that the inertia moment and max. rotational speed do not exceed the allowable values shown in the table on the following page.

When a load generating a large inertia moment is operated frequently, a greater regenerative energy will be produced during braking. If the regenerative energy produced exceeds the absorption capacity of the built-in regenerative resistor of the servo amplifier, an additional regenerative resistor must be connected externally to the servo amplifier. For details, refer to the manual of your servo amplifier.

SG type

Actuator model		SHA20P				
		51	81	101	121	161
Reduction ratio		1:51	1:81	1:101	1:121	1:161
Max. rotational speed	r/min	117.6	74.1	59.4	49.6	37.3
Actuator inertia moment (without brake)	kg·m ²	0.23	0.58	0.91	1.3	2.3
	kgf·cm·s ²	2.4	6.0	9.3	13	24
Actuator inertia moment (with brake)	kg·m ²	0.26	0.65	1.0	1.4	2.6
	kgf·cm·s ²	2.6	6.6	10	15	26
Allowable load inertia moment	kg·m ²	2.4	3.8	4.8	5.8	7.7
	kgf·cm·s ²	25	39	49	59	78

Actuator model		SHA25P				
		51	81	101	121	161
Reduction ratio		1:51	1:81	1:101	1:121	1:161
Max. rotational speed	r/min	109.8	69.1	55.4	46.3	34.8
Actuator inertia moment (without brake)	kg·m ²	0.56	1.4	2.2	3.2	5.6
	kgf·cm·s ²	5.7	14	22	32	57
Actuator inertia moment (with brake)	kg·m ²	0.66	1.7	2.6	3.7	6.6
	kgf·cm·s ²	6.7	17	26	38	67
Allowable load inertia moment	kg·m ²	5.6	8.8	11	14	20
	kgf·cm·s ²	57	90	112	144	201

Actuator model		SHA32P				
		51	81	101	121	161
Reduction ratio		1:51	1:81	1:101	1:121	1:161
Max. rotational speed	r/min	94.1	59.3	47.5	39.7	29.8
Actuator inertia moment (without brake)	kg·m ²	2.0	5.1	8.0	11	20
	kgf·cm·s ²	21	52	81	117	207
Actuator inertia moment (with brake)	kg·m ²	2.3	5.9	9.2	13	23
	kgf·cm·s ²	24	60	94	135	238
Allowable load inertia moment	kg·m ²	20	32	40	50	70
	kgf·cm·s ²	200	320	400	510	710

Actuator model		SHA40P					SHA45P				
		51	81	101	121	161	51	81	101	121	161
Reduction ratio		1:51	1:81	1:101	1:121	1:161	1:51	1:81	1:101	1:121	1:161
Max. rotational speed	r/min	78.4	49.4	39.6	33.1	24.8	74.5	46.9	37.6	31.4	23.6
Actuator inertia moment (without brake)	kg·m ²	5.0	13	20	28	50	6.8	17	27	38	68
	kgf·cm·s ²	51	130	202	290	513	69	175	272	390	690
Actuator inertia moment (with brake)	kg·m ²	6.1	15	24	34	61	7.9	20	31	45	79
	kgf·cm·s ²	62	157	244	350	619	81	204	316	454	804
Allowable load inertia moment	kg·m ²	58	92	114	137	182	75	119	148	178	236
	kgf·cm·s ²	590	930	1170	1400	1860	766	1215	1514	1814	2413

Actuator model		SHA58P				SHA65P			
		81	101	121	161	81	101	121	161
Reduction ratio		1:81	1:101	1:121	1:161	1:81	1:101	1:121	1:161
Max. rotational speed	r/min	37.0	29.7	24.8	18.6	34.6	27.7	23.1	17.4
Actuator inertia moment (without brake)	kg·m ²	96	149	214	379	110	171	245	433
	kgf·cm·s ²	980	1520	2180	3870	1120	1740	2500	4420
Actuator inertia moment (with brake)	kg·m ²	106	165	237	420	120	187	268	475
	kgf·cm·s ²	1090	1690	2420	4290	1230	1910	2740	4850
Allowable load inertia moment	kg·m ²	290	450	640	1140	360	560	810	1420
	kgf·cm·s ²	2900	4600	6500	11600	3700	5700	8200	14500

CG type

Actuator model		SHA20P				
		50	80	100	120	160
Reduction ratio		1:50	1:80	1:100	1:120	1:160
Max. rotational speed	r/min	120	75	60	50	37.5
Actuator inertia moment (without brake)	kg·m ²	0.21	0.53	0.82	1.2	2.1
	kgf·cm·s ²	2.1	5.4	8.0	12	22
Actuator inertia moment (with brake)	kg·m ²	0.23	0.60	0.94	1.3	2.4
	kgf·cm·s ²	2.4	6.1	9.6	14	24
Allowable load inertia moment	kg·m ²	2.4	3.8	4.8	5.8	7.7
	kgf·cm·s ²	25	39	49	59	78

Actuator model		SHA25P				
		50	80	100	120	160
Reduction ratio		1:50	1:80	1:100	1:120	1:160
Max. rotational speed	r/min	112	70	56	46.7	35
Actuator inertia moment (without brake)	kg·m ²	0.50	1.3	2.0	2.9	5.1
	kgf·cm·s ²	5.1	13	20	29	52
Actuator inertia moment (with brake)	kg·m ²	0.60	1.5	2.4	3.4	6.1
	kgf·cm·s ²	6.1	16	24	35	62
Allowable load inertia moment	kg·m ²	5.6	8.8	11	14	20
	kgf·cm·s ²	57	90	112	144	201

Actuator model		SHA32P				
		50	80	100	120	160
Reduction ratio		1:50	1:80	1:100	1:120	1:160
Max. rotational speed	r/min	96	60	48	40	30
Actuator inertia moment (without brake)	kg·m ²	1.7	4.3	6.7	9.7	17
	kgf·cm·s ²	17	44	68	99	175
Actuator inertia moment (with brake)	kg·m ²	2.0	5.1	7.9	11	20
	kgf·cm·s ²	20	52	81	116	207
Allowable load inertia moment	kg·m ²	20	32	40	50	70
	kgf·cm·s ²	200	320	400	510	710

Actuator model		SHA40P				
		50	80	100	120	160
Reduction ratio		1:50	1:80	1:100	1:120	1:160
Max. rotational speed	r/min	80	50	40	33.3	25
Actuator inertia moment (without brake)	kg·m ²	4.8	12	19	27	49
	kgf·cm·s ²	49	124	194	280	497
Actuator inertia moment (with brake)	kg·m ²	5.8	15	23	33	59
	kgf·cm·s ²	59	150	235	338	601
Allowable load inertia moment	kg·m ²	58	92	114	137	182
	kgf·cm·s ²	590	930	1170	1400	1860

2-2 Change in load inertia moment

For SHA-P series combined with the high reduction ratio of HarmonicDrive®, the effects of change in load inertia moment on the servo performance are minimal. In comparison to direct servo drive mechanisms, therefore, this benefit allows the load to be driven with a better servo response.

For example, assume that the load inertia moment increases to N-times. The total inertia moment converted to motor shaft which has an effect on servo response is as follows:

The symbols in the formulas are:

J_s : Total inertia moment converted to motor shaft

J_M : Inertia moment of motor

R : Reduction ratio of SHA-P series actuator

L : Ratio of load inertia moment to inertia moment of motor

N : Rate of change in load inertia moment

- Direct drive

$$\text{Before: } J_s = J_M(1+L) \quad \text{After: } J_{s'} = J_M(1+NL) \quad \text{Ratio: } J_{s'}/J_s = \frac{1+NL}{1+L}$$

- Driven by SHA-P series

$$\text{Before: } J_s = J_M \left(1 + \frac{L}{R^2} \right) \quad \text{After: } J_{s'} = J_M \left(1 + \frac{NL}{R^2} \right) \quad \text{Ratio: } J_{s'}/J_s = \frac{1+NL/R^2}{1+L/R^2}$$

With SHA-P series, the value of R increases from 50 to 161, which means that the value increases substantially from $R^2 = 2500$ to $R^2 = 25921$. Then the ratio is $J_{s'}/J_s \approx 1$. This means that SHA-P drive systems are hardly affected by the load variation.

Therefore, it is not necessary to take change in load inertia moment into consideration when selecting SHA-P series actuator or setting up the initial servo amplifier parameters.

2-3 Verifying and examining load weights

The SHA-P series actuator incorporates a precise cross roller bearing for directly supporting an external load (output flange). To demonstrate the full ability of the actuator, verify the maximum load moment load as well as the life and static safety coefficient of the cross roller bearing.

Checking procedure

1 Verifying the maximum load moment load (M_{max})

Calculating the maximum load moment load (M_{max})



Verifying the maximum load moment load (M_{max}) is less than or equal to the permissible moment load (M_c)

2 Verifying life

Calculate the average radial load (F_{rav}) and average axial load (F_{aav}).



Calculate the radial load coefficient (X) and the axial load coefficient (Y).



Calculate the life of the bearing and verify the life is allowable.

3 Verifying the static safety coefficient

Calculate the static equivalent radial load (P_o).



Verify the static safety coefficient (f_s).

Specifications of the main roller bearing

The following table shows the specifications of the main roller bearings built in SHA-P actuators.

Table 1: Specifications of the main roller bearings

Model	Item	Circular pitch of the roller (dp)	Offset amount (R)	Basic dynamic rated load (C)	Basic static rated load (C ₀)	Permissible moment load (M _c)	Moment stiffness (K _m)
		mm	mm	kN	kN	N·m	×10 ⁴ N·m/rad
	SHA20P-SG	70	23.5	14.6	22	187	25.2
	SHA20P-CG	70	19.5	14.6	22	187	25.2
	SHA25P-SG	85	27.6	21.8	35.8	258	39.2
	SHA25P-CG	85	21.6	21.8	35.8	258	39.2
	SHA32P-SG	111	34.9	38.2	65.4	580	100
	SHA32P-CG	111	25.4	38.2	65.4	580	100
	SHA40P-SG	133	44	43.3	81.6	849	179
	SHA40P-CG	133	29.5	43.3	81.6	849	179
	SHA45P-SG	154	47.5	77.6	135	1127	257
	SHA58P-SG	195	62.2	87.4	171	2180	531
	SHA65P-SG	218	69	130	223	2740	741

Maximum load moment load

The formula below shows how to calculate the maximum load moment load (M_{max}).

Verify that the maximum load moment load (M_{max}) is less than or equal to the permissible moment load (M_c).

◆ **Formula (1): Maximum load moment load**

$$M_{max} = \frac{Fr_{max} \cdot (L_r + R) + Fa_{max} \cdot La}{1000}$$

Symbols used in the formula

M_{max}	Maximum load moment load	N · m	
Fr_{max}	Max. radial load	N	Refer to Fig.1.
Fa_{max}	Max. axial load	N	Refer to Fig.1.
L_r, La		mm	Refer to Fig.1.
R	Offset amount	mm	Refer to Fig.1 and Table 1.

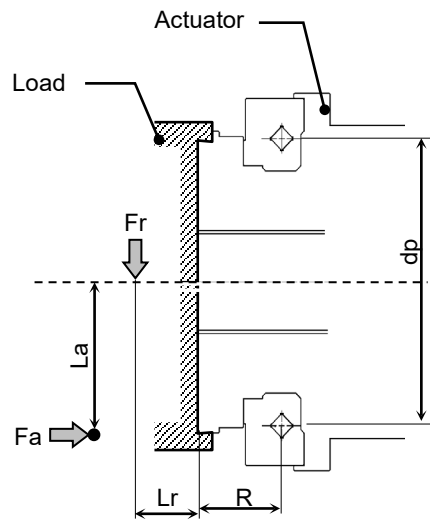

Fig. 1: External load action

Verifying life

Calculating average loads (average radial and axial loads, average output rotational speed)

When the radial and/or axial loads vary during motion, calculate and verify the life of the cross roller bearing converting the loads to their average values.

◆ **Formula (2): Average radial load (F_{rav})**

$$F_{rav} = \sqrt[10/3]{\frac{n_1 t_1 |Fr_1|^{10/3} + n_2 t_2 |Fr_2|^{10/3} + \dots + n_n t_n |Fr_n|^{10/3}}{n_1 t_1 + n_2 t_2 + \dots + n_n t_n}}$$

The maximum radial load in section t_1 is given by Fr_1 , while the maximum radial load in section t_3 is given by Fr_3 .

◆ **Formula (3): Average axial load (F_{aav})**

$$F_{aav} = \sqrt[10/3]{\frac{n_1 t_1 |Fa_1|^{10/3} + n_2 t_2 |Fa_2|^{10/3} + \dots + n_n t_n |Fa_n|^{10/3}}{n_1 t_1 + n_2 t_2 + \dots + n_n t_n}}$$

The maximum axial load in section t_1 is given by Fa_1 , while the maximum axial load in section t_3 is given by Fa_3 .

◆ **Formula (4): Average output rotational speed (N_{av})**

$$N_{av} = \frac{n_1 t_1 + n_2 t_2 + \dots + n_n t_n}{t_1 + t_2 + \dots + t_n}$$

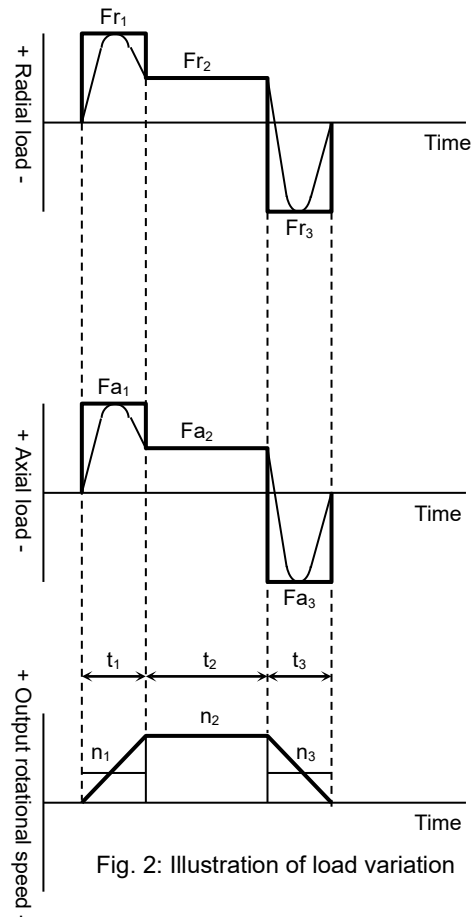

Fig. 2: Illustration of load variation

Radial load coefficient and axial load coefficient

Determine the values of radial load coefficient (X) and axial load coefficient (Y) based on conditional judgment according to formula (5).

Table 2: Radial load coefficient (X), axial load coefficient (Y)

◆ Formula (5)	X	Y
$\frac{F_{aav}}{F_{rav} + 2(F_{rav}(L_r + R) + F_{aav} \cdot L_a)/d_p} \leq 1.5$	1	0.45
$\frac{F_{aav}}{F_{rav} + 2(F_{rav}(L_r + R) + F_{aav} \cdot L_a)/d_p} > 1.5$	0.67	0.67

Symbols used in the formulas

F_{rav}	Average radial load	N	Refer to the average load.
F_{aav}	Average axial load	N	Refer to the average load.
L_r, L_a	—	mm	Refer to Fig.1.
R	Offset amount	mm	Refer to Fig.1 and Table 1.
d_p	Pitch circle diameter of a roller	mm	Refer to Fig.1 and Table 1.

Dynamic equivalent radial load

◆ Formula (6): Dynamic equivalent radial load

$$P_c = X \cdot \left(F_{rav} + \frac{2(F_{rav}(L_r + R) + F_{aav} \cdot L_a)}{d_p} \right) + Y \cdot F_{aav}$$

Symbols used in the formulas

P_c	Dynamic equivalent radial load	N	
F_{rav}	Average radial load	N	Obtained by formula (2).
F_{aav}	Average axial load	N	Obtained by formula (3).
d_p	Pitch circle diameter of a roller	mm	Refer to Table 1.
X	Radial load coefficient	—	Refer to Table 2.
Y	Axial load coefficient	—	Refer to Table 2.
L_r, L_a	—	mm	Refer to Fig.1.
R	Offset amount	mm	Refer to Fig.1 and Table 1.

Life of cross roller bearing

Calculate the life of cross roller bearing with the formula (7):

◆ Formula (7): Cross roller bearing life

$$L_{B-10} = \frac{10^6}{60 \times N_{av}} \times \left(\frac{C}{f_w \cdot P_c} \right)^{10/3}$$

Symbols used in the formulas

L_{B-10}	Life	hour	—
N_{av}	Average output rotational speed	r/min	Obtained by formula (4).
C	Basic dynamic rated load	N	Refer to Table 1.
P_c	Dynamic equivalent radial load	N	Obtained by formula (6).
f_w	Load coefficient	—	Refer to Table 3.

Table 3: Load coefficient

Loaded state	f_w
Smooth operation free from impact/vibration	1 to 1.2
Normal operation	1.2 to 1.5
Operation subject to impact/vibration	1.5 to 3

Cross roller bearing life based on oscillating movement

Use formula (8) to calculate the cross roller bearing life against oscillating movement.

◆ Formula (8): Cross roller bearing life (oscillating)

$$L_{oc} = \frac{10^6}{60 \times n_1} \times \frac{90}{\theta} \times \left(\frac{C}{f_w \cdot P_c} \right)^{10/3}$$

Symbols used in the formulas

Symbol	Description	Unit	Reference
L_{oc}	Life	hour	—
n_1	Number of reciprocating oscillation per min.	cpm	—
C	Basic dynamic rated load	N	Refer to Table 1.
P_c	Dynamic equivalent radial load	N	Obtained by formula (6).
f_w	Load coefficient	—	Refer to Table 3.
θ	Oscillating angle/2	—	Refer to Fig. 3.

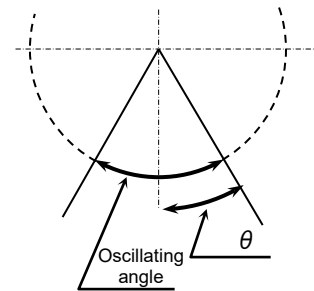

Fig. 3: Oscillating movement

If the oscillating angle is 5° or less, fretting wear may occur because oil film does not form effectively on the contact surface between the race and rolling element of the cross roller bearing. In such cases, consult HDS.

Verifying static safety coefficients

Static equivalent radial load

◆ Formula (9): Static equivalent radial load

$$P_o = F_{rmax} + \frac{2M_{max}}{dp} + 0.44F_{amax}$$

Symbols used in the formulas

Symbol	Description	Unit	Reference
F_{rmax}	Max. radial load	N	Refer to Fig. 1.
F_{amax}	Max. axial load	N	Refer to Fig. 1.
M_{max}	Max. moment load	N·m	Refer to the maximum load weight calculation methods.
dp	Pitch circle diameter of a roller	mm	Refer to Table 1.

Static safety coefficient

Generally, the static equivalent load is limited by the basic static rated load (C_o). However, the specific limit should be calculated according to the using conditions and required conditions. In this case, calculate the static safety coefficient (f_s) by formula (10).

Table 4 shows general values representing using conditions. Calculate the static equivalent radial load (P_o) by formula (9).

◆ Formula (10): Static safety coefficient

$$f_s = \frac{C_o}{P_o}$$

Symbols used in the formulas

Symbol	Description	Unit	Reference
f_s	Static safety coefficient	—	Refer to Table 4.
C_o	Basic static rated load	N	Refer to Table 1.
P_o	Static equivalent radial load	N	Obtained by formula (9).

Table 4: Static safety coefficients

Using conditions	f_s
High rotational accuracy is required, etc.	≥ 3
Operation subject to impact/vibration	≥ 2
Normal operation	≥ 1.5

2-4 Verifying operating conditions

The actuator generates heat if started/stopped repeatedly or operated continuously at high speed. Accordingly, examine whether or not the generated heat can be accommodated. The study is as follows:

Examining actuator rotation speed

Calculate the actuator rotation speed [r/min] of the load driven by SHA-P series. For linear operation, use the rotation speed conversion formula below:

$$\text{Actuator rotational speed [r/min]} = \frac{\text{Linear travel speed [mm/min]}}{\text{Screw feed pitch [mm]}}$$

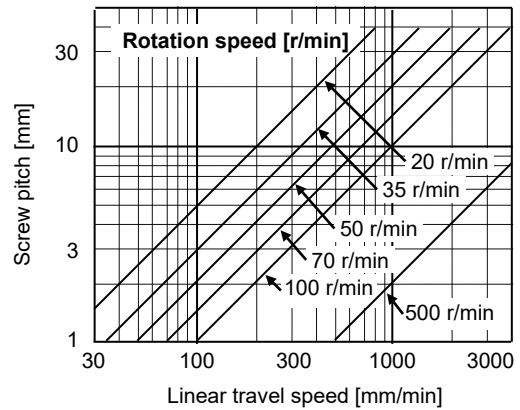

Select an appropriate reduction ratio from 50, 51, 80, 81, 100, 101, 120, 121, 160 and 161 so that the calculated actuator rotation speed does not exceed the maximum rotational speed of SHA-P series actuator.

Calculating and examining load inertia moment

Calculate the load inertia moment of the load driven by SHA-P series actuator. Refer to [A-2 Calculating inertia moment] (PA-3) for the calculation. Based on the calculated result, tentatively select SHA-P series actuator by referring to [Allowable load inertia moment] (P2-1).

Load torque calculation

Calculate the load torque as follows:

- Rotary motion

The rotary torque for the rotating mass W on the ring of radius r from the center of rotation is shown in the figure to the right.

$$T = 9.8 \times \mu \times W \times r$$

T : Rotary torque [N·m]

μ : Friction coefficient

W : Mass [kg]

r : Average radius of friction side [m]

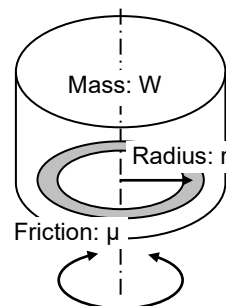

- Linear operation (horizontal operation)

The rotary torque when the mass W moves horizontally due to the screw of pitch P is shown below.

$$T = 9.8 \times \mu \times W \times \frac{P}{2 \times \pi}$$

T : Rotary torque [N·m]

μ : Friction coefficient

W : Mass [kg]

P : Screw feed pitch [m]

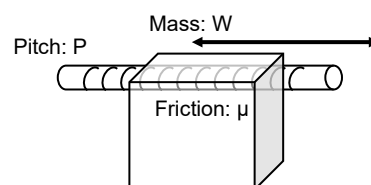

- Linear operation (vertical operation)

The rotary torque when the mass W moves vertically due to the screw of pitch P is shown below.

$$T = 9.8 \times W \times \frac{P}{2 \times \pi}$$

T : Rotary torque [N·m]

W : Mass [kg]

P : Screw feed pitch [m]

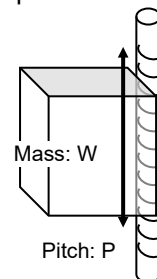

2

Selection guidelines

Acceleration time and deceleration time

Calculate acceleration and deceleration times for the selected actuator.

$$\text{Acceleration time: } t_a = k \times (J_A + J_L) \times \frac{2 \times \pi}{60} \times \frac{N}{T_M - T_L}$$

$$\text{Deceleration time: } t_d = k \times (J_A + J_L) \times \frac{2 \times \pi}{60} \times \frac{N}{T_M + 2 \times T_F + T_L}$$

t_a : Acceleration time [s]

t_d : Deceleration time [s]

k : Acceleration reduction coefficient 1 to 1.5
The total positioning time may become shorter if the acceleration is lowered for the purpose of reducing the settling time after positioning.

J_A : Actuator inertia moment [kg·m²]

J_L : Load inertia moment [kg·m²]

N : Actuator rotation speed [r/min]

T_M : Maximum actuator torque [N·m]

T_F : Actuator friction torque [N·m]

$$T_F = K_T \times I_R - T_R$$

K_T : Torque constant [N·m/A]

T_R : Allowable continuous torque [N·m]

I_R : Allowable continuous current [A]

T_L : Load torque [N·m]

The polarity is positive (+) when the torque is applied in the rotation direction, or negative (-) when it is applied in the opposite direction.

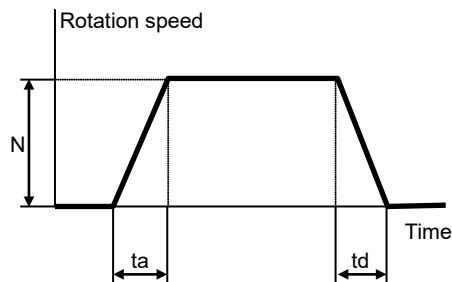

● **Calculation example 1**

Select an actuator that best suits the following operating conditions:

- Rotation speed: 80 [r/min]
- Load inertia moment: 1.5 [kg·m²]
- Since the load mechanism is mainly inertia, the load torque is negligibly small.

(1) After applying these conditions to the graph in [2-1], SHA25P51SG-B09A200 is tentatively selected.

(2) From the rated table, the following values are obtained:

$$J_A = 0.56 \text{ [kg·m}^2\text{]}$$

$$T_M = 127 \text{ [N·m]}$$

$$T_R = 41 \text{ [N·m]}$$

$$K_T = 19 \text{ [N·m/A]}$$

$$I_R = 3 \text{ [A]}$$

(3) Based on the above formula, the actuator's friction torque T_F is calculated as

$$19 \times 3 - 41 = 16 \text{ [N·m].}$$

(4) If $k = 1.3$, the acceleration time and deceleration time can be obtained as follows from the above formulas:

$$t_a = 1.3 \times (0.56 + 1.5) \times 2 \times \pi / 60 \times 80 / 127 = 0.177 \text{ [s]}$$

$$t_d = 1.3 \times (0.56 + 1.5) \times 2 \times \pi / 60 \times 80 / (127 + 2 \times 16) = 0.141 \text{ [s]}$$

(5) If the calculated acceleration/deceleration times are too long, correct the situation by:

- Reducing load inertia moment
- Selecting an actuator with a larger frame size

Examining effective torque and average rotation speed

One way to check if the heat generated from the actuator during operation would present a problem is to determine if the point of operation, determined by the effective torque and average rotation speed, is inside the continuous motion range explained in [1-14 Operable range] (P1-43).

Using the following formula, calculate the effective torque T_m and average rotation speed N_{av} when the actuator is operated repeatedly in the drive pattern shown to the right.

$$T_m = \sqrt{\frac{T_a^2 \times t_a + T_r^2 \times t_r + T_d^2 \times t_d}{t}}$$

$$N_{av} = \frac{N/2 \times t_a + N \times t_r + N/2 \times t_d}{t}$$

t_a	: Acceleration time from speed 0 to N	[s]
t_d	: Deceleration time from speed N to 0	[s]
t_r	: Operation time at constant speed N	[s]
t	: Cycle time	[s]
T_m	: Effective torque	[N·m]
T_a	: Torque during acceleration	[N·m]
T_r	: Torque at constant speed	[N·m]
T_d	: Torque during deceleration	[N·m]
N_{av}	: Average rotation speed	[r/min]
N	: Rotation speed at constant speed	[r/min]

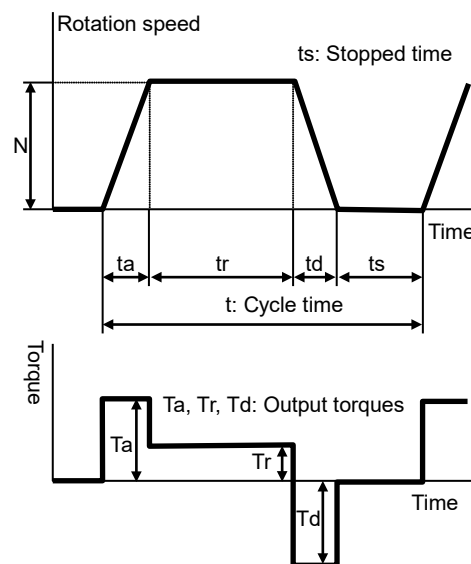

● Calculation example 2

An example of SHA25P51SG-B09A200 is explained.

Operating conditions: Accelerate an inertia load and then let it move at a constant speed, followed by deceleration, based on conditions similar to those used in calculation example 1. The travel angle per cycle is 120° and the cycle time is 1 second.

(1) The travel angle is calculated from the area of the rotation speed vs. time diagram shown above. In other words, the travel angle θ is calculated as follows:

$$\theta = (N / 60) \times \{t_r + (t_a + t_d) / 2\} \times 360$$

$$\text{Accordingly, } t_r = \theta / (6 \times N) - (t_a + t_d) / 2$$

When $\theta = 120^\circ$, and

$$t_a = 0.177 \text{ [s]}$$

$$t_d = 0.141 \text{ [s]}$$

$$N = 80 \text{ [r/min]}$$

in calculation example 1, are applied to this formula, t_r is calculated as 0.091 second.

(2) Next, calculate the torque during acceleration and torque during deceleration. Based on the acceleration/deceleration time formulas in the preceding section, the relational expressions for torque during acceleration and torque during deceleration if $k = 1$ are as follows:

$$T_a = (J_A + J_L) \times 2 \times \pi / 60 \times N / t_a + T_L$$

$$T_d = (J_A + J_L) \times 2 \times \pi / 60 \times N / t_d - 2 \times T_F - T_L$$

When the values in calculation example 1 are applied to this formula,

$$T_a = 98 \text{ [N·m]} \text{ and}$$

$$T_d = 90 \text{ [N·m]}$$

are obtained.

(3) Calculate the effective torque. Apply the values in (1) and (2), and $T_r = 0 \text{ N·m}$ and $t = 1$ second, to the above formulas.

$$T_m = \sqrt{\frac{98^2 \times 0.177 + 0^2 \times 0.091 + 90^2 \times 0.141}{1}} = 53 \text{ [N·m]}$$

- (4) Calculate the average rotation speed. Apply the values in (1), and $N = 80$ r/min and $t = 1$ second, to the above formulas.

$$N_{av} = \frac{80/2 \times 0.177 + 80 \times 0.091 + 80/2 \times 0.141}{1} = 20 \text{ [r/min]}$$

- (5) The figure on the right shows the points of operation determined by the effective torque and average rotation speed calculated above, plotted on the graph of operable range of SHA25P51SG, exceeding the continuous motion range. The conclusion is that this actuator cannot be operated continuously under these conditions. Accordingly,

- ◆ the operation pattern
- ◆ load (possible reduction)
- ◆ actuator size No.

etc., must be reexamined.

The following formula is a modified version of the formula for effective torque. By applying the value of allowable continuous torque to T_m in this formula, the allowable cycle time can be calculated.

$$t = \frac{T_a^2 \times t_a + T_r^2 \times t_r + T_d^2 \times t_d}{T_m^2}$$

Apply the following:

- $T_a = 98$ [N·m]
- $T_r = 0$ [N·m]
- $T_d = 90$ [N·m]
- $T_m = 41$ [N·m]
- $t_a = 0.177$ [s]
- $t_r = 0.091$ [s]
- $t_d = 0.141$ [s]

Then, the following equation is obtained:

$$t = \frac{98^2 \times 0.177 + 90^2 \times 0.141}{41^2} = 1.69 \text{ [s]}$$

Based on the result, setting the cycle time to 1.7 seconds or more to provide a longer stopped time gives $T_m = 41$ N·m or less, thereby permitting continuous operation within the allowable continuous torque.

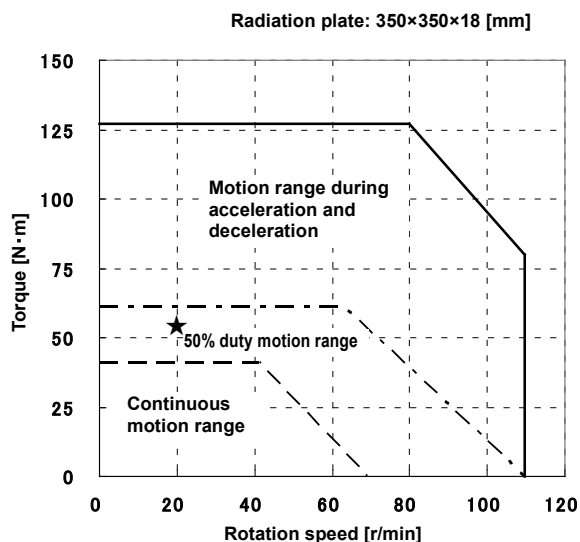

Operable range of SHA25P51SG

Caution

- The aforementioned continuous motion range represents an allowable range where the actuator installed on a specified aluminum radiation plate is operated under natural air cooling. If the radiation area of the mounting member is small or heat conduction of the material is poor, adjust the operating conditions to keep the rise in the actuator's ambient temperature to 40 K or less as a guide.

Chapter 3

Installing SHA-P actuator

The following explains the installation procedures of the actuators.

3-1	Product Verification	3-1
3-2	Notices on handling	3-2
3-3	Location and installation	3-6

3-1 Product Verification

Check the following items after unpacking the package.

Verification steps

1 Check the items thoroughly for damage sustained during transportation.

If any item is damaged, immediately contact the dealer.

2 Check if the actuator is what you ordered.

The nameplate is found on the rear end face of SHA-P series actuator. Check the TYPE field on the nameplate to confirm that it is indeed the model you have ordered. If any item is wrong, immediately contact the dealer.

Refer to the section [1-2 Model] (P1-3) in this manual for the detail of the model codes.

3 Check if the servo amplifier combinations are correct.

Check that this is the model combination given in this document in [1-3 Combinations with servo amplifier and extension cables] (P1-4) column.

4 Check if the input voltage being input are correct.

The value of the power voltage input is shown in the servo amplifier nameplate "INPUT" column. If the voltage to be supplied is different from the label voltage, immediately contact the dealer it was purchased from.



WARNING

Do not combine with an actuator other than the one given in this document.

The characteristics of the servo amplifier have been adjusted according to the actuator. A wrong combination of "servo amplifier" and "actuator" may cause inadequate torque or overcurrent that may cause burn damage to the actuator, injury or fire.

Do not connect a supply voltage other than the voltage specified on the servo amplifier's nameplate.

Connecting a power supply not matching the input voltage specified on the nameplate may result in damage to the servo amplifier, injury or fire.

3-2 Notices on handling

Handle SHA-P series actuator carefully by observing the notices specified below.



- (1) Do not apply any excessive force or impact, especially to the actuator's output shaft.
- (2) Do not put SHA-P series actuator on a table, shelf, etc., where the actuator could easily fall.
- (3) Do not connect the actuator terminals directly to the power supply. The actuator may burn and cause fire or electric shock.
- (4) The allowable storage temperature is -20 to $+60$ °C. Do not expose the actuator to direct sunlight for long periods of time or store it in areas in low or high temperature.
- (5) The allowable relative storage humidity is 80 % or less. Do not store the actuator in a very humid place or in areas where temperatures are likely to fluctuate greatly during day and night.
- (6) Do not use or store the actuator in locations subject to flammable or corrosive gases or dust particles.
- (7) The large sizes (SHA58P, SHA65P) are heavy. Handling these sizes may cause lower back pain, or injury if the actuator drops or topples and you get pinned underneath. Handle your actuator with due care by wearing safety shoes or take other proper precaution and also by using supporting jigs.

Installation and transmission torque

Examples of actuator assembly are shown below. Assembly examples 1 and 2 are for SG type, 3 and 4 are for CG type. Use high-tension bolts and tighten them with a torque wrench to control the tightening torque. In assembly example 2 to 4, use flat washers because the tightening torque is high and the actuator flange is made of aluminum.

SG type assembly example

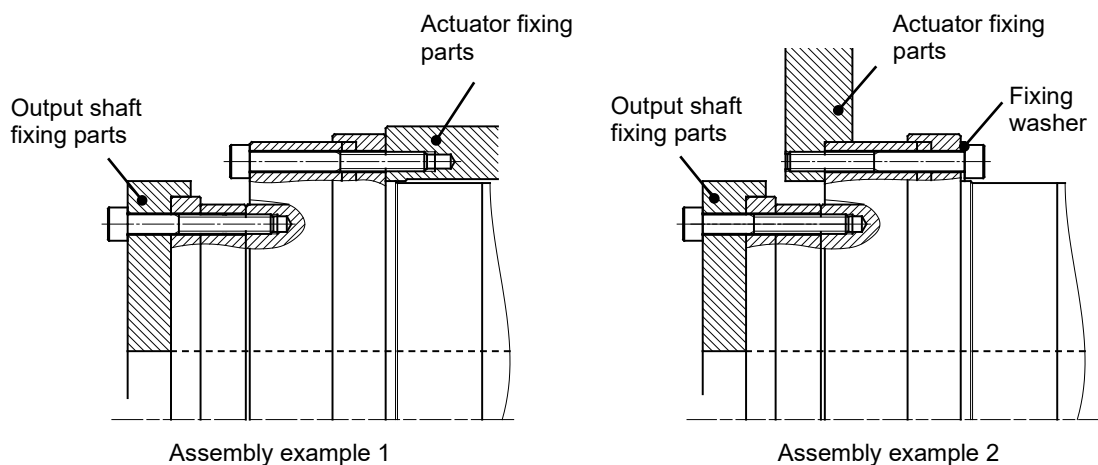

CG type assembly example

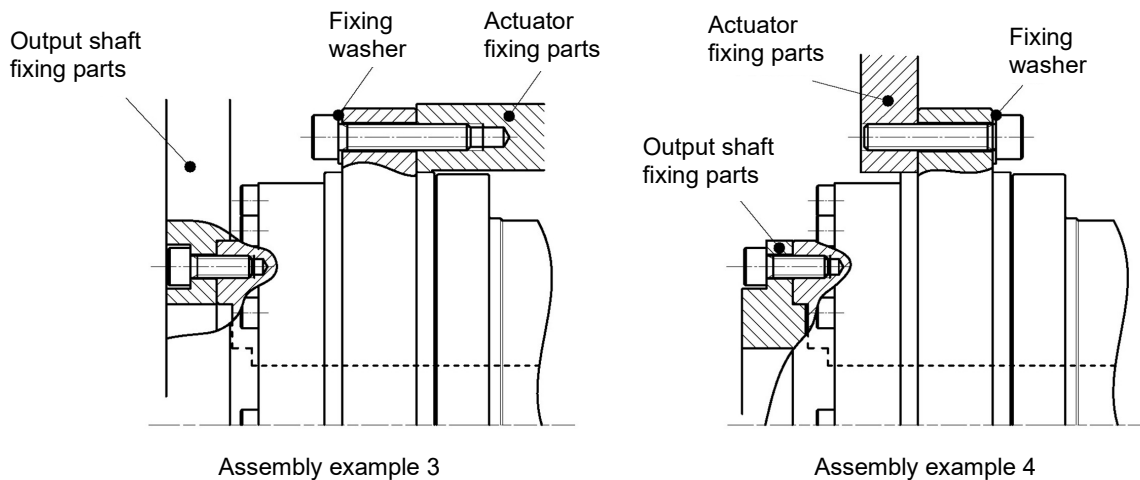

Assembly example 3

Assembly example 4

● Recommended tightening torque and transmission torque

SG type

Item \ Model		SHA20P		SHA25P		SHA32P	
		Output shaft	Actuator	Output shaft	Actuator	Output shaft	Actuator
Number of bolts, size		16-M3	12-M3	16-M4	12-M4	16-M5	12-M5
Bolt installation P.C.D.	mm	62	84	77	102	100	132
	N·m	2.0	2.0	4.5	4.5	9	9
Tightening torque	Kgf·m	0.20	0.20	0.46	0.46	0.92	0.92
	N·m	203	206	433	430	900	891
Transmission torque	Kgf·m	21	21	44	44	92	91

Item \ Model		SHA40P		SHA45P		SHA58P		SHA65P	
		Output shaft	Actuator	Output shaft	Actuator	Output shaft	Actuator	Output shaft	Actuator
Number of bolts, size		16-M6	12-M6	12-M8	18-M6	12-M10	16-M8	16-M10	16-M10
Bolt installation P.C.D.	mm	122	158	140	180	178	226	195	258
	N·m	15.3	15.3	37	15.3	74	37	74	74
Tightening torque	Kgf·m	1.56	1.56	3.8	1.56	7.5	3.8	7.5	7.5
	N·m	1560	1510	2428	2582	4940	5230	7210	9550
Transmission torque	Kgf·m	159	154	248	263	504	533	735	974

CG type

Item \ Model		SHA20P		SHA25P	
		Output shaft	Actuator	Output shaft	Actuator
Number of bolts, size		12-M4	6-M5	12-M5	8-M6
Bolt installation P.C.D.	mm	60	107	72	131
Tightening torque	N·m	4.5	6.4	9	11
	kgf·m	0.46	0.65	0.92	1.1
Transmission torque	N·m	253	257	486	600
	kgf·m	26	26	50	61

Item \ Model		SHA32P		SHA40P	
		Output shaft	Actuator	Output shaft	Actuator
Number of bolts, size		12-M6	12-M6	12-M8	8-M10
Bolt installation P.C.D.	mm	96	162	116	203
Tightening torque	N·m	15.3	11	37	52
	kgf·m	1.6	1.1	3.8	5.3
Transmission torque	N·m	918	1114	2012	2639
	kgf·m	94	114	205	269

Note 1) The female thread material is premised to withstand the bolt tightening torque.

2) Recommended bolt: Hexagonal bolt per JIS B 1176 Intensity category: JIS B 1051 12.9 or higher

3) Calculation conditions Torque efficiency: 0.2 Tightening efficiency: 1.4 Tightening friction coefficient: 0.15

Precautions on installation

When designing the assembly, take note that application of any abnormal or excessive force that causes deformation of the installation surface may result in performance drop. To demonstrate the excellent performance of SHA-P series actuator fully, take note of the following points:

- Warp and deformation on the mounting surface
- Blocking of foreign matter
- Burrs, rising and abnormal position accuracy around tapped mounting holes
- Insufficient chamfering of mounting faucet joint
- Abnormal circularity of mounting faucet joint

When the installation method is as shown in assembly example 2 on the previous page, the recessing shown to the right is recommended for the fixing part mounting faucet joint corner section.

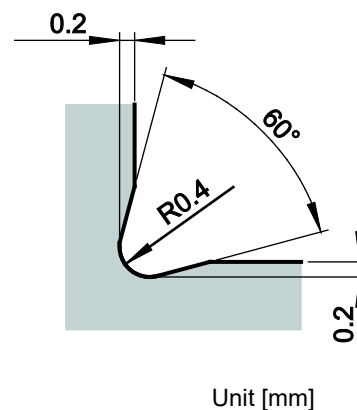

Use of positioning pins

The SHA-P series SG type has positioning pin holes in the output rotary unit and flange fixed to the actuator. The SHA-P series CG type has positioning pin holes only in the output rotary unit. Use these pins as necessary. For details, refer to [1-6 External dimensions] (P1-19) or the illustrated specifications.

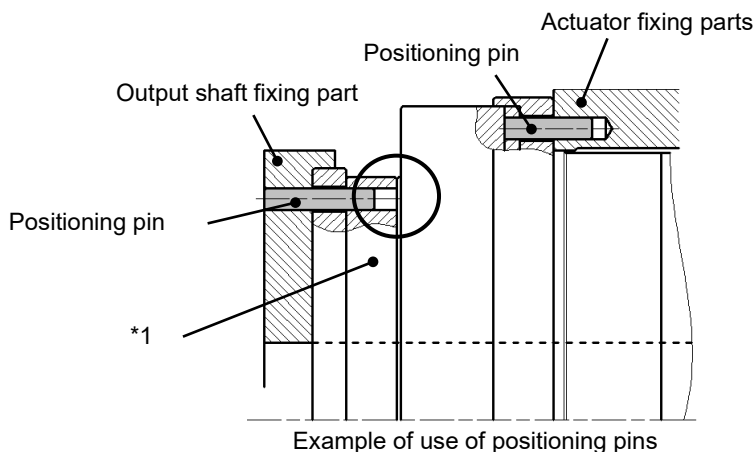

*1. Do not drive positioning pins into the output rotary unit, but keep proper fitting clearances to the actuator parts. Failure to do so may result in lower positional accuracy.

Surface treatments

Standard SHA-P series actuators are given the following surface treatments:

SG type

Location	Surface treatments
Housing	No treatment (aluminum material is exposed)
Output shaft bearing	Low temperature, black chrome plating
Speed reducer rotating part	Chrome plating
Output flange	Nickel plating or Low temperature, black chrome plating
Hollow shaft (sleeve)	Nickel plating
Bolt	Black oxide coating treatment

CG type

Location	Surface treatments
Housing	No treatment (aluminum material is exposed)
Output shaft bearing	Low temperature, black chrome plating
Speed reducer rotating part	Low temperature, black chrome plating
Hollow shaft (sleeve)	Nickel plating, enamel resin is applied to some surfaces
Bolt	Chrome plating or Nickel plating

The surface treatments given to SHA-P series actuators do not fully prevent rust.

3-3 Location and installation

Installing environment

The environmental conditions of the installation location for SHA-P series actuators must be as follows. Determine an appropriate installation location by observing these conditions without fail.

- ◆ Operating temperature: 0 to 40 °C
The temperature in the cabinet may be higher than the atmosphere depending on the power loss of housed devices and size of the cabinet. Plan the cabinet size, cooling system, and device locations so the ambient temperature of the actuator is kept 40 °C or below.
- ◆ Operating humidity: Relative humidity of 20 to 80 %.
Make sure no condensation occurs. Take note that condensation is likely to occur in a place where there is a large temperature change between day and night or when the actuator is started/stopped frequently.
- ◆ Vibration: 25 m/s² (10 to 400 Hz) or less (Refer to [1-13 Resistance to vibration] (P1-42).)
- ◆ Impact: 300 m/s² or less (Refer to [1-12 Shock resistance] (P1-41).)
- ◆ Use environment: Free from condensation, metal powder, corrosive gases, water, oil mist, flammable gases, etc.
- ◆ Protection class: Standard products are structurally designed to meet the IP-54 requirements.

The protection class against water entry is as follows:
4: Protected against water splashed from all directions.

The protection class against contact and entry of foreign matter is as follows:
5: Protected against entry of dust/dirt. Entry of water or foreign matter caused by incomplete protection must not affect the operation of the system.

However, rotating and sliding areas (oil seal areas) and connectors of SHA20P, 25P, 32P, 40P and 45P are not IP-54-compliant. Also, SHA58P and 65P connector sections are protected in fitted conditions.

- ◆ Locate the driver indoors or within an enclosure. Do not expose it to the sunlight.
- ◆ Altitude: lower than 1000 m above sea level
- ◆ The oil seals in rotating and sliding areas do not fully prevent leakage of lubricant. If the actuator is used in a clean room, etc., provide additional oil leakage prevention measures.

Installation

The SHA-P series actuator drives mechanical load system at high accuracy. When installing the actuator, pay attention to precision and do not tap the actuator output part with a hammer, etc. The actuator houses an encoder. Excessive impact may damage the encoder.

Installation procedure

1 Align the axis of rotation of the actuator and the load mechanism precisely.

Note 1: Perform this alignment carefully, especially when a rigid coupling is used. Even slight misalignment may cause the permissible load of the actuator to be exceeded, resulting in damage to the output shaft.

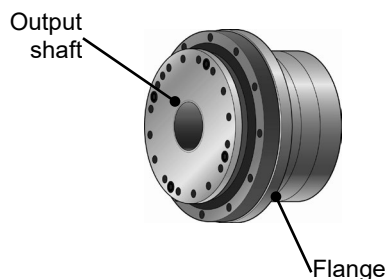

2 Connect the servo amplifier and wiring.

An extension cable is provided. Use it when wiring the servo amplifier. For details on wiring, refer to [1-15 Cable specifications] (P1-55) and the manual of your MINAS A6 servo amplifier.

3 Wire the motor cable and encoder cable.

Do not pull the cables with a strong force. The connection points may be damaged. Install the cable with slack not to apply tension to the actuator. Provide a sufficient bending radius (at least 6 times the cable diameter), especially when the cable flexes.

Caution

- Do not bring strong magnetic bodies (magnet chucks, permanent magnets, etc.) near the rear cover of the actuator. Encoder abnormality may result.
- This encoder requires an external battery to retain absolute positions.



Do not disassemble/reassemble the actuator.

The actuator uses many precision parts. If the actuator is disassembled/reassembled by the customer, it may cause burned damage or uncontrollable operation of the actuator, resulting in fire or injury.

Chapter 4

Options

This chapter explains the options available for SHA-P series actuator.

4-1 Options.....	4-1
------------------	-----

4-1 Options

With near origin and end limit sensors (option code: L)

Revolution sensors are directly connected to the output shaft on the counter-output side of the actuator. Use this option if the mechanical origin is needed (when the virtual origin of the absolute encoder does not do the job) or you want to define an operation range as a safety measure. This option is not available with SHA20P.

Cable taken out from side face (option code: Y)

The cables (motor and encoder wires) are taken out from the side face of the actuator. Use this option if the actuator is housed in a system and there is not enough space at the rear of the housing.

This option is not available with the SHA20P (SG type), SHA58P and SHA65P.
For details on cable taken out from side face, contact our sales office.

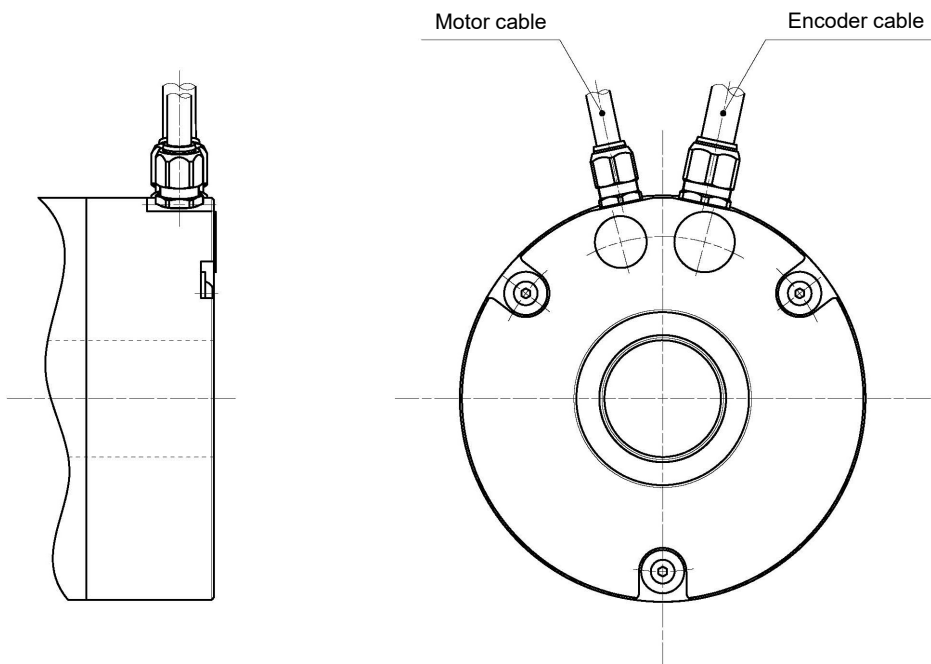

With stand (CG type, option code: V)

The model with an optional stand is available for purchase to use the CG type for table drive.

- Outline drawing of the actuator with an optional stand

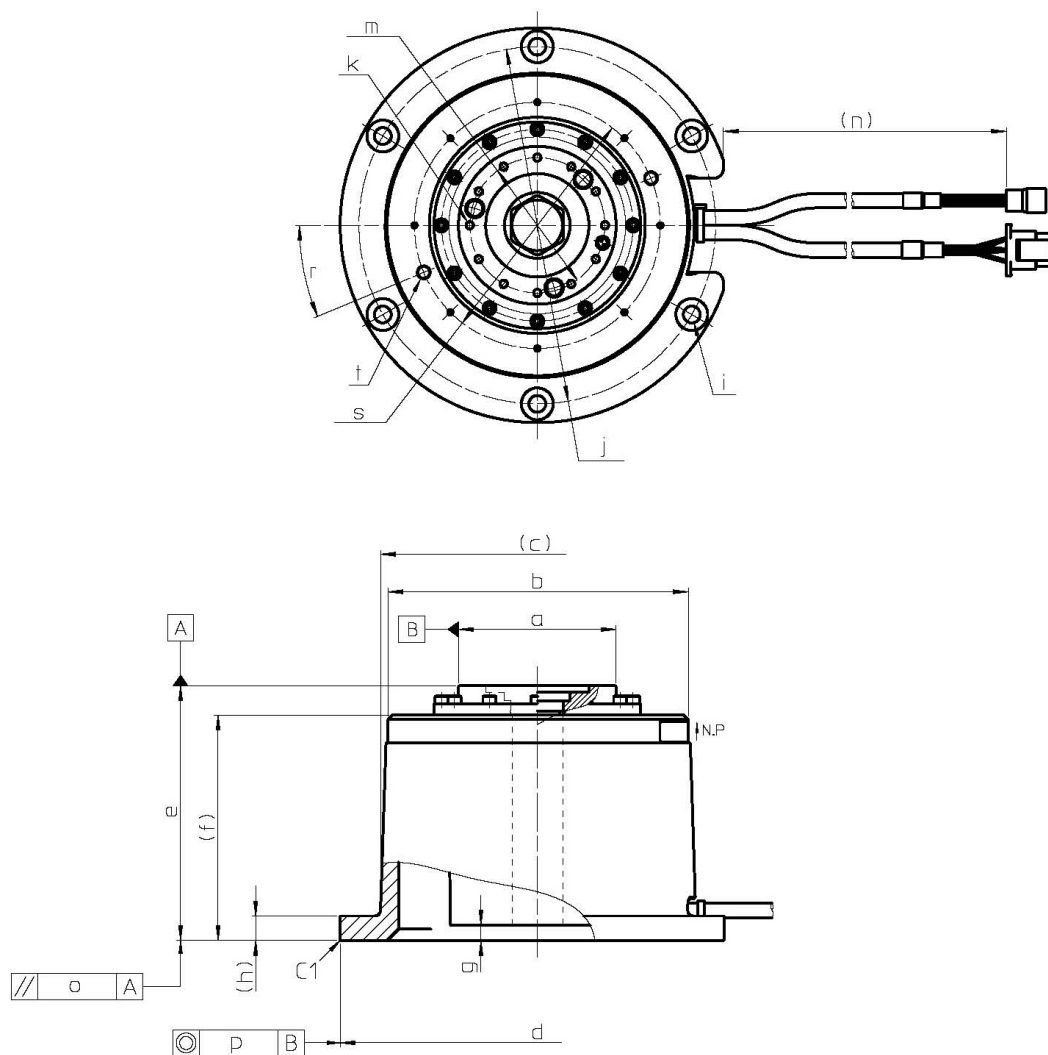

- * For models with a stand, the cable is taken out from the side of the actuator (option code: Y). Models with near home & end limit sensors (option code: L) are not supported.

● Dimensions and installation specifications of the actuator with an optional stand

Item	Unit	SHA20P	SHA25P	SHA32P	SHA40P
a	mm	$\phi 69 \text{ h7 } 0/-0.030$	$\phi 84 \text{ h7 } 0/-0.035$	$\phi 110 \text{ h7 } 0/-0.035$	$\phi 132 \text{ h7 } 0/-0.040$
b	mm	$\phi 135$	$\phi 160$	$\phi 198$	$\phi 248$
c	mm	$\phi 143$	$\phi 168$	$\phi 208$	$\phi 258$
d	mm	$\phi 177 \text{ h7 } 0/-0.040$	$\phi 210 \text{ h7 } 0/-0.046$	$\phi 260 \text{ h7 } 0/-0.052$	$\phi 316 \text{ h7 } 0/-0.057$
e	mm	133 ± 0.3	135.5 ± 0.3	152 ± 0.3	180 ± 0.3
f	mm	118	120	133	163
g	mm	7.5	8	8	10
h	mm	11	13	13	20
i	mm	6- $\phi 6.6$ counterbore $\phi 13$ depth 1	6- $\phi 9$ counterbore $\phi 17$ depth 1	6- $\phi 11$ counterbore $\phi 21$ depth 1	6- $\phi 13$ counterbore $\phi 25$ depth 1
j	mm	$\phi 161$	$\phi 190$	$\phi 234$	$\phi 288$
k	-	12-M4 \times 7	12-M5 \times 8	12-M6 \times 10	12-M8 \times 12
m	mm	$\phi 60$	$\phi 72$	$\phi 96$	$\phi 116$
n	mm	170	160	150	130
o ^{Note1)}	mm	0.050	0.055	0.060	0.070
p ^{Note1)}	mm	$\phi 0.080$	$\phi 0.080$	$\phi 0.090$	$\phi 0.100$
r	°	60	22.5	45	90
s	mm	$\phi 107$	$\phi 131$	$\phi 162$	$\phi 203$
t	mm	2-M6 depth 11	2-M8 depth 13	2-M8 depth 15	2-M12 depth 23
Mass ^{Note2)}	kg	4.4 (4.5)	6.1 (6.2)	11.6 (11.9)	20 (21)
Section i ^{Note 5)} Bolts used	-	6-M6	6-M8	6-M10	6-M12
Section i Recommended tightening torque	N·m	11	26	52	90

Note 1) All values are T.I.R. (Total Indicator Reading).

2) The values in parentheses are for models with a brake.

3) For detailed dimensions and specifications of the actuator, refer to the illustrated specifications.

4) Cast aluminum is used for the material of the stand. No surface treatment has been applied.

5) Use flat washers when installing the product.

Extension cables

These extension cables are used to connect SHA-P series actuators and MINAS A6 servo amplifiers. Two types of extension cables are available for motor (including brake wire) and absolute encoder. You must use an extension cable to connect your SHA-P series actuator and MINAS A6 servo amplifier. For details on encoder extension cables, contact Panasonic Corporation.

Motor extension cable:

- Actuator size No. 20, 25, 32, 40, 45

EWD-MB**-A06-TN-P

Indicates the cable length (03 = 3 m, 05 = 5 m, 10 = 10 m, 20 = 20 m).

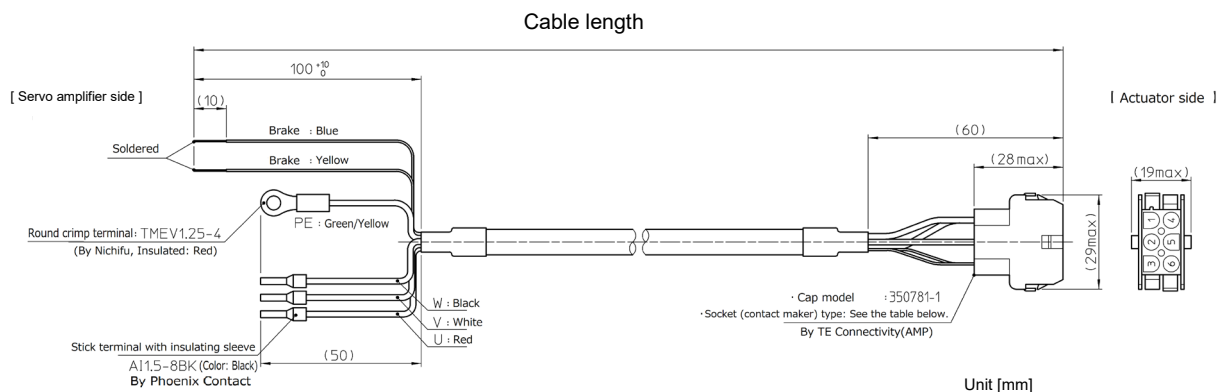

● **Actuator size No. 58, 65**

EWD-MB**-D09-TMC-P

Indicates the cable length (03 = 3 m, 05 = 5 m, 10 = 10 m, 20 = 20 m).

[Actuator side]

[Servo amplifier side]

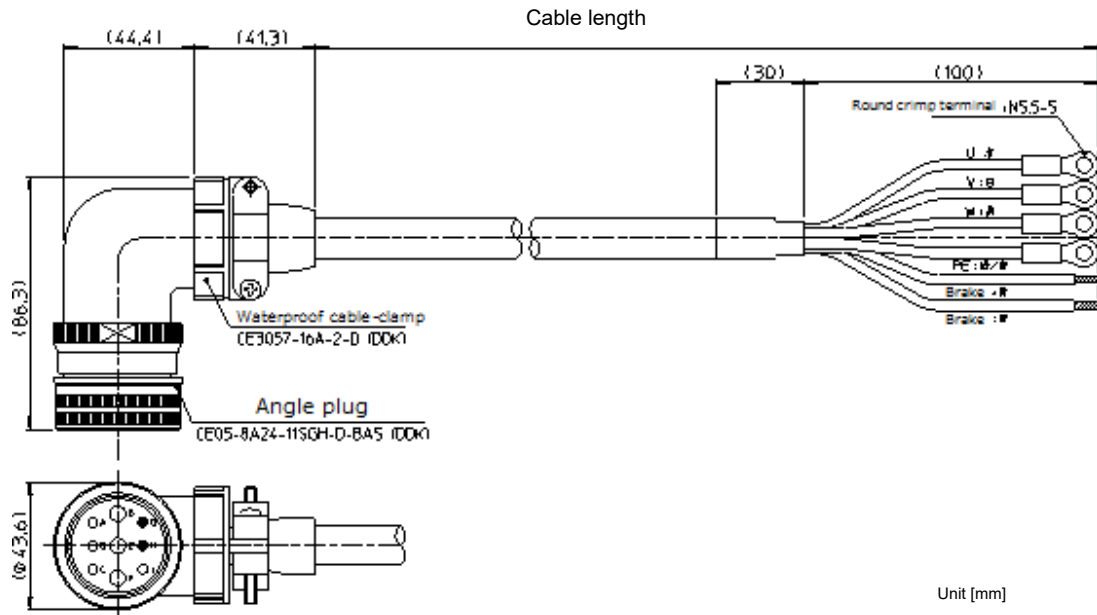

Unit [mm]

Encoder extension cable:

● **Actuator size No. 20, 25, 32, 40, 45**

MFECA0**0EAE (With battery box)

Indicates the cable length (03 = 3 m, 05 = 5 m, 10 = 10 m, 20 = 20 m).

● **Actuator size No. 58, 65**

MFECA0**0ETE (With battery box)

Indicates the cable length (03 = 3 m, 05 = 5 m, 10 = 10 m, 20 = 20 m).

Appendix

A-1 Unit conversion	A-1
A-2 Calculating inertia moment	A-3

A-1 Unit conversion

This manual employs SI system for units. Conversion factors between the SI system and other systems are as follows:

(1) Length

SI system	m	
↓		
Unit	ft.	in.
Factor	3.281	39.37

(2) Linear speed

SI system	m/s			
↓				
Unit	m/min	ft./min	ft./s	in/s
Factor	60	196.9	3.281	39.37

(3) Linear acceleration

SI system	m/s ²			
↓				
Unit	m/min ²	ft./min ²	ft./s ²	in/s ²
Factor	3600	1.18x10 ⁴	3.281	39.37

(4) Force

SI system	N		
↓			
Unit	kgf	lb (force)	oz (force)
Factor	0.102	0.225	4.386

(5) Mass

SI system	kg	
↓		
Unit	lb.	oz.
Factor	2.205	35.27

(6) Angle

SI system	rad		
↓			
Unit	deg.	min.	sec.
Factor	57.3	3.44x10 ³	2.06x10 ⁵

(7) Angular speed

SI system	rad/s			
↓				
Unit	deg/s	deg/min	r/s	r/min
Factor	57.3	3.44x10 ³	0.1592	9.55

Unit	ft.	in.
Factor	0.3048	0.0254
↓		
SI system	m	

Unit	m/min	ft./min	ft./s	in/s
Factor	0.0167	5.08x10 ⁻³	0.3048	0.0254
↓				
SI system	m/s			

Unit	m/min ²	ft./min ²	ft./s ²	in/s ²
Factor	2.78 x10 ⁻⁴	8.47x10 ⁻⁵	0.3048	0.0254
↓				
SI system	m/s ²			

Unit	kgf	lb (force)	oz (force)
Factor	9.81	4.45	0.278
↓			
SI system	N		

Unit	lb.	oz.
Factor	0.4535	0.02835
↓		
SI system	kg	

Unit	deg.	min.	sec.
Factor	0.01755	2.93x10 ⁻⁴	4.88x10 ⁻⁶
↓			
SI system	rad		

Unit	deg/s	deg/min	r/s	r/min
Factor	0.01755	2.93x10 ⁻⁴	6.28	0.1047
↓				
SI system	rad/s			

(8) Angular acceleration

SI system	rad/s ²	
↓		
Unit	deg/s ²	deg/min ²
Factor	57.3	3.44x10 ³

Unit	deg/s ²	deg/min ²
Factor	0.01755	2.93x10 ⁻⁴
↓		
SI system	rad/s ²	

(9) Torque

SI system	N·m			
↓				
Unit	kgf·m	lb·ft	lb·in	oz·in
Factor	0.102	0.738	8.85	141.6

Unit	kgf·m	lb·ft	lb·in	oz·in
Factor	9.81	1.356	0.1130	7.06x10 ⁻³
↓				
SI system	N·m			

(10) Inertia moment

SI system	kg·m ²							
↓								
Unit	kgf·m·s ²	kgf·cm·s ²	lb·ft ²	lb·ft·s ²	lb·in ²	lb·in·s ²	oz·in ²	oz·in·s ²
Factor	0.102	10.2	23.73	0.7376	3.42x10 ³	8.85	5.47x10 ⁴	141.6

Unit	kgf·m·s ²	kgf·cm·s ²	lb·ft ²	lb·ft·s ²	lb·in ²	lb·in·s ²	oz·in ²	oz·in·s ²
Factor	9.81	0.0981	0.0421	1.356	2.93x10 ⁻⁴	0.113	1.829x10 ⁻⁵	7.06x10 ⁻³

SI system	kg·m ²							
-----------	-------------------	--	--	--	--	--	--	--

(11) Torsional spring constant, moment stiffness

SI system	N·m/rad				
↓					
Unit	kgf·m/rad	kgf·m/arc-min	kgf·m/deg	lb·ft/deg	lb·in/deg
Factor	0.102	2.97 x10 ⁻⁵	1.78x10 ⁻³	0.0129	0.1546

Unit	kgf·m/rad	kgf·m/arc-min	kgf·m/deg	lb·ft/deg	lb·in/deg
Factor	9.81	3.37 x10 ⁴	562	77.6	6.47

SI system	N·m/rad				
-----------	---------	--	--	--	--

A-2 Calculating inertia moment

Formula of mass and inertia moment

(1) Both centerlines of rotation and gravity are the same:

The following table includes formulas to calculate mass and inertia moment.

m : mass [kg], I_x, I_y, I_z : inertia moments which rotates around x-, y-, z-axes respectively [kg·m²]

G : distance from end face of gravity center [m]

ρ : specific gravity [$\times 10^3$ kg / m³]

Unit Inertia moment [kg·m²]

Apx

Appendix

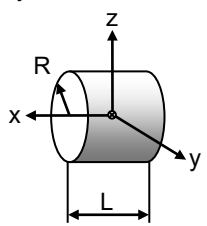
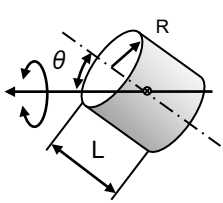
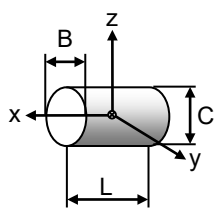
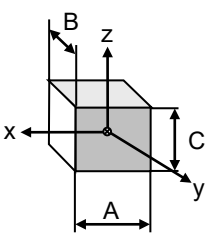
Object form	Mass, inertia, gravity center
	$m = \pi R^2 L \rho$ $I_x = \frac{1}{2} m R^2$ $I_y = \frac{1}{4} m \left(R^2 + \frac{L^2}{3} \right)$ $I_z = \frac{1}{4} m \left(R^2 + \frac{L^2}{3} \right)$
	$m = \pi R^2 L \rho$ $I_\theta = \frac{1}{12} m \times \left\{ 3R^2(1 + \cos^2\theta) + L^2 \sin^2\theta \right\}$
	$I_x = \frac{1}{16} m (B^2 + C^2)$ $I_y = \frac{1}{4} m \left(\frac{C^2}{4} + \frac{L^2}{3} \right)$ $I_z = \frac{1}{4} m \left(\frac{B^2}{4} + \frac{L^2}{3} \right)$
	$m = ABC\rho$ $I_x = \frac{1}{12} m (B^2 + C^2)$ $I_y = \frac{1}{12} m (C^2 + A^2)$ $I_z = \frac{1}{12} m (A^2 + B^2)$

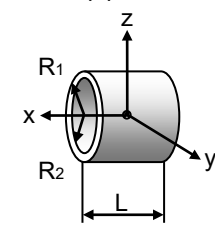
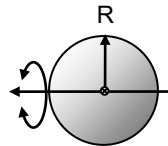
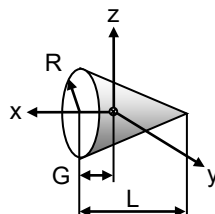
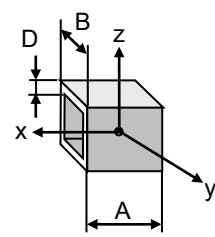
Object form	Mass, inertia, gravity center
	$m = \pi (R_1^2 - R_2^2) L \rho$ $I_x = \frac{1}{2} m (R_1^2 + R_2^2)$ $I_y = \frac{1}{4} m \left\{ (R_1^2 + R_2^2) + \frac{L^2}{3} \right\}$ $I_z = \frac{1}{4} m \left\{ (R_1^2 + R_2^2) + \frac{L^2}{3} \right\}$ <p>R1: Outer diameter R2: Inner diameter</p>
	$m = \frac{4}{3} \pi R^3 \rho$ $I = \frac{2}{5} m R^2$
	$m = \frac{1}{3} \pi R^2 L \rho$ $I_x = \frac{3}{10} m R^2$ $I_y = \frac{3}{80} m (4R^2 + L^2)$ $I_z = \frac{3}{80} m (4R^2 + L^2)$ $G = \frac{L}{4}$
	$m = 4AD(B - D)\rho$ $I_x = \frac{1}{3} m \left\{ (B \cdot D)^2 + D^2 \right\}$ $I_y = \frac{1}{6} m \left\{ \frac{A^2}{2} + (B \cdot D)^2 + D^2 \right\}$ $I_z = \frac{1}{6} m \left\{ \frac{A^2}{2} + (B \cdot D)^2 + D^2 \right\}$

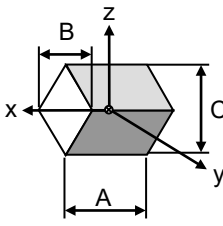
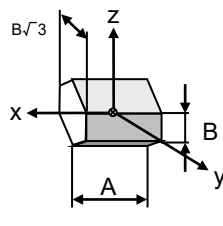
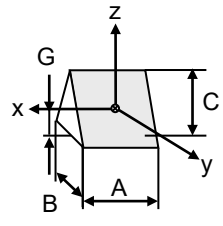
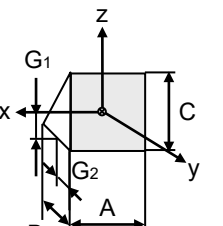
Object form	Mass, inertia, gravity center	Object form	Mass, inertia, gravity center
	$m = \frac{1}{2} ABC\rho$ $I_x = \frac{1}{24} m(B^2 + C^2)$ $I_y = \frac{1}{24} m(C^2 + 2A^2)$ $I_z = \frac{1}{24} m(B^2 + 2A^2)$		$m = \frac{3\sqrt{3}}{2} AB^2\rho$ $I_x = \frac{5}{12} mB^2$ $I_y = \frac{1}{12} m\left(A^2 + \frac{5}{2}B^2\right)$ $I_z = \frac{1}{12} m\left(A^2 + \frac{5}{2}B^2\right)$
	$m = \frac{1}{2} ABC\rho$ $I_x = \frac{1}{12} m\left(\frac{B^2}{2} + \frac{2}{3}C^2\right)$ $I_y = \frac{1}{12} m\left(A^2 + \frac{2}{3}C^2\right)$ $I_z = \frac{1}{12} m\left(A^2 + \frac{B^2}{2}\right)$ $G = \frac{C}{3}$		$m = \frac{1}{2} ABC\rho$ $I_x = \frac{1}{36} m(B^2 + C^2)$ $I_y = \frac{1}{12} m\left(A^2 + \frac{2}{3}C^2\right)$ $I_z = \frac{1}{12} m\left(A^2 + \frac{2}{3}B^2\right)$ $G_1 = \frac{C}{3} \quad G_2 = \frac{B}{3}$

Apx
Appendix

● **Example of specific gravity**

The following tables show references of specific gravity. Confirm the specific gravity for the material of the drive load.

Material	Specific gravity [$\times 10^3 \text{kg} / \text{m}^3$]	Material	Specific gravity [$\times 10^3 \text{kg} / \text{m}^3$]	Material	Specific gravity [$\times 10^3 \text{kg} / \text{m}^3$]
SUS304	7.93	Aluminum	2.70	Epoxy resin	1.90
S45C	7.86	Duralumin	2.80	ABS	1.10
SS400	7.85	Silicon	2.30	Silicon resin	1.80
Cast iron	7.19	Quartz glass	2.20	Polyurethane rubber	1.25
Copper	8.92	Teflon	2.20		
Brass	8.50	Fluorocarbon resin	2.20		

(2) Both centerlines of rotation and gravity are not the same:

The following formula calculates the inertia moment when the rotary center is different from the gravity center.

$$I = I_g + mF^2$$

I: Inertia moment when the gravity center axis does not match the rotational axis [$\text{kg} \cdot \text{m}^2$]

I_g : Inertia moment when the gravity center axis matches the rotational axis [$\text{kg} \cdot \text{m}^2$]

Calculate according to the shape by using formula (1).

m: mass [kg]

F: Distance between rotary center and gravity center [m]

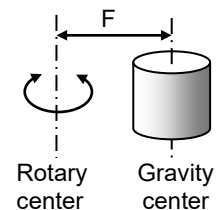

(3) Inertia moment of linear operation objects

The inertia moment, converted to actuator axis, of a linear motion object driven by a screw, etc., is calculated using the formula below.

$$I = m\left(\frac{P}{2\pi}\right)^2$$

I: Inertia moment of a linear operation object converted to actuator axis [$\text{kg} \cdot \text{m}^2$]

m: mass [kg]

P: Linear travel per actuator one revolution [m/rev]

Warranty Period and Terms

The equipment listed in this document is warranted as follows:

■ Warranty period

Under the condition that the actuator are handled, used and maintained properly followed each item of the documents and the manuals, all the applicable products are warranted against defects in workmanship and materials for the shorter period of either one year after delivery or 2,000 hours of operation time.

■ Warranty terms

All the applicable products are warranted against defects in workmanship and materials for the warranted period. This limited warranty does not apply to any product that has been subject to:

- (1) user's misapplication, improper installation, inadequate maintenance, or misuse.
- (2) disassembling, modification or repair by others than Harmonic Drive Systems, Inc.
- (3) imperfection caused by a non-applicable product.
- (4) disaster or others that does not belong to the responsibility of Harmonic Drive Systems, Inc.

Our liability shall be limited exclusively to repairing or replacing the product only found by Harmonic Drive Systems, Inc. to be defective. Harmonic Drive Systems, Inc. shall not be liable for consequential damages of other equipment caused by the defective products, and shall not be liable for the incidental and consequential expenses and the labor costs for detaching and installing to the driven equipment.

Harmonic Drive LLC

Boston US Headquarters

42 Dunham Ridge
Beverly, MA 01915

New York Sales Office

100 Motor Parkway
Suite 116
Hauppauge, NY 11788



California Sales Office

333 W. San Carlos Street
Suite 1070
San Jose, CA 95110

Chicago Sales Office

137 N. Oak Park Ave.
Suite 410
Oak Park, IL 60301

T: 800.921.3332
T: 978.532.1800
F: 978.532.9406
www.HarmonicDrive.net

Group Companies

Harmonic Drive Systems, Inc.
6-25-3 Minami-Ohi, Shinagawa-ku
Tokyo 141-0013, Japan

Harmonic Drive SE
Hoenbergstrasse, 14, D-65555
Limburg/Lahn Germany

